



THE CAMBRIDGE GLASS COMPANY, CAMBRIDGE, OHIO, U.S.A.

Fine handmade
table glassware
by



THE CAMBRIDGE GLASS COMPANY, CAMBRIDGE, OHIO, U.S.A.

Alphabetical Index

Accessories	148	Modern	152
Achilles	89	Mt. Vernon	127
Adonis	95	Old English	116
Allegro	124	Old Master	116
Ardsley	91	Orion	113
Arlington	131	Paisley	74
Aurora	123	Pristine	26
Barsemble	119	Punch Sets	50
Bexley	90	Queen Mary	145
Blue Danube	117	Regency	128
Cadet	107	Rondo	102
Cambridge Arms	69	Rose Point	78
Cambridge Rose	91	Gold Edge	158
Cambridge Square	6	Gold Encrusted	158
Candelabra	62	Roses	94
Candlesticks	60	Roxbury	99
Caprice	14	Salt-Pepper	64
Cascade	122	Simplicity	144
Castleton	125	Smokers' Items	46
Chantilly	76	Sonata	36
Charleston	130	Star	107
Connoisseur	132	Starburst	115
Corinth	20	Starlite	115
Croesus	95	Sugar-Cream	64
Crown	113	Swans	53
Danube, Blue	117	Tempo	98
Decanters	48	3109 Line	136
Dunkirk	138	3121 Line	139
Epergnnes	54	3139 Line	140
Festoon	117	3779 Line	141
Flame	114	3600 Line	142
Flight	114	3625 Line	143
Floral Arrangers	59	Today	134
Formal	118	Tomorrow	94
Gadroon	129	Triumph	154
Georgian Line	39	Trumpet	137
Gifts	40	Tumblers	56
Glendale	112	Vases	66
Harvest	110	Victory	153
Heirloom	133	Wedding Band	156
Invitation	135	Wedding Rings	96
Jefferson	126	Wildflower	79
King Edward	92	Gold Edge	158
Laurel Wreath	104	Gold Encrusted	158
Lynbrook	108		

Index

PATTERNS, PLAIN

Cambridge Square	6, 7, 8, 9, 10, 11, 12, 13
Caprice	14, 15, 16, 17, 18, 19
Corinth	20, 21, 22, 23, 24, 25
Pristine	26, 27, 28, 29, 30, 31, 32, 33, 34, 35
Sonata	36, 37, 38

MISCELLANEOUS

Candelabra	62, 63
Candlesticks	60, 61
Decanters	48, 49
Epergnes	54, 55
Floral Arrangements	59
Georgian Line	39
Gifts	40, 41, 42, 43, 44, 45
Punch Sets	50, 51, 52
Salt-Pepper-Cream-Sugar	64, 65
Smokers' Items	46, 47
Swans	53
Tumblers	56, 57, 58
Vases	66, 67, 68

CAMBRIDGE ARMS	69, 70, 71, 72
----------------------	----------------

ETCHED DESIGNS

Chantilly	76, 77, 79, 81, 83, 84, 85, 86, 87
Paisley	74, 75
Rose Point	78, 79, 81, 82, 83, 84, 85, 86, 87
Wildflower	79, 80, 81, 82, 83, 84, 85, 86, 87

ROCK CRYSTAL, ENGRAVED

Achilles	89
Adonis	95
Ardley	91
Barsemble	119
Bexley	90
Blue Danube	117
Cadet	107
Cambridge Rose	91
Croesus	95
Crown	113
Festoon	117
Flame	114
Flight	114

Formal	118
Glendale	112
Harvest	110, 111
King Edward	92, 93
Laurel Wreath	104, 105, 106
Lynbrook	108, 109
Old English	116
Old Master	116
Orion	113
Rondo	102, 103
Roses	94
Roxbury	99, 100, 101
Star	107
Starburst	115
Starlite	115
Tempo	98, 100, 101
Tomorrow	94
Wedding Rings	96, 97

STEMWARE, PLAIN

3109 Line	136
3121 Line	139
3139 Line	140
3600 Line	142
3625 Line	143
3779 Line	141
Allegro	124
Arlington	131
Aurora	123
Cascade	122, 123
Castleton	125
Charleston	130
Connoisseur	132
Dunkirk	138
Gadroon	129
Heirloom	133
Invitation	135
Jefferson	126
Mt. Vernon	127
Queen Mary	145
Regency	128
Simplicity	144
Today	134
Trumpet	137

ACCESSORIES for Cambridge Arms, Candelabra, Epergnes, Hurricane Lamps	148, 149
--	----------

GOLD & PLATINUM DECORATIONS

Modern	152
Rose Point — Gold Edge	158, 159
Rose Point — Gold Encrusted	158, 159
Triumph	154, 155
Victory	153
Wedding Band	156, 157
Wild Flower — Gold Edge	158, 159
Wild Flower — Gold Encrusted	158, 159

*There is hardly anything in the world
that some man cannot make a little worse
and sell a little cheaper, and the people
who consider price only are this man's
lawful prey.*—JOHN RUSKIN



THE CAMBRIDGE GLASS COMPANY, CAMBRIDGE, OHIO, U.S.A.

Cambridge

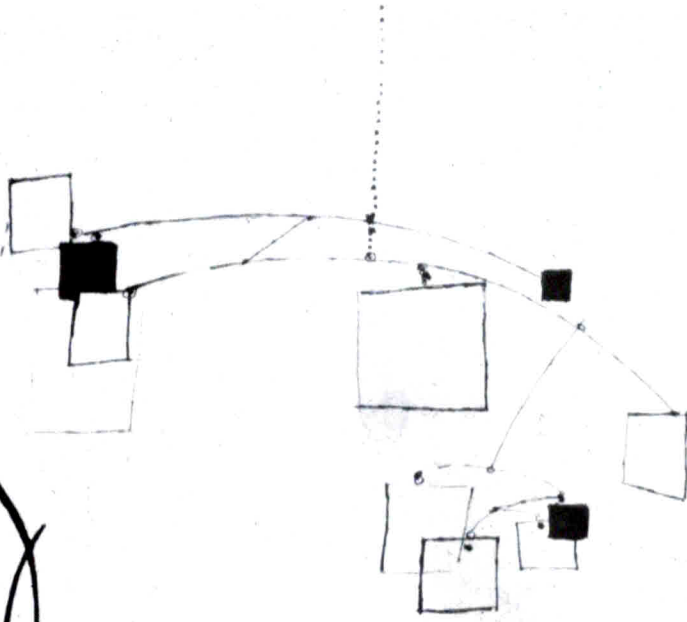

Square

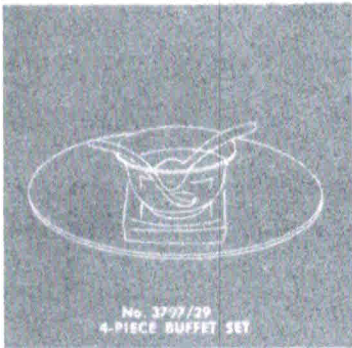

No. 3797/29
4-PIECE BUFFET SET

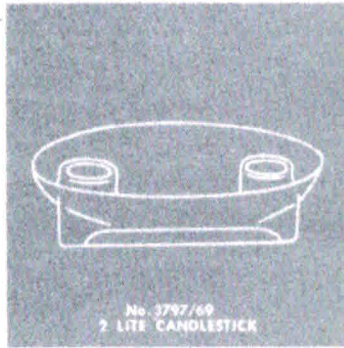

No. 3797/69
2 LITE CANDLESTICK

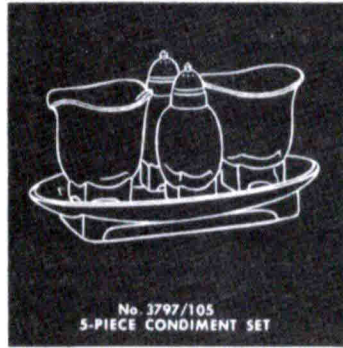

No. 3797/105
5-PIECE CONDIMENT SET

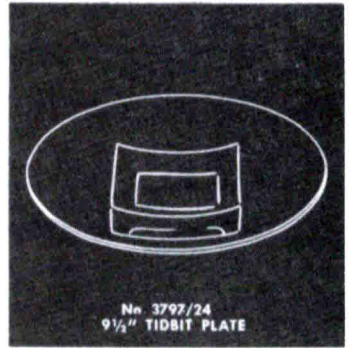

No. 3797/24
9 1/2" TIDBIT PLATE



No. 3797/100 - 4 1/2 OZ. OIL

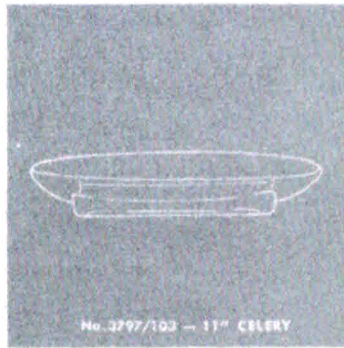

No. 3797/102 - 11" CELERY

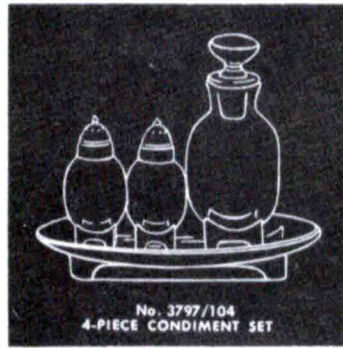

No. 3797/104
4-PIECE CONDIMENT SET

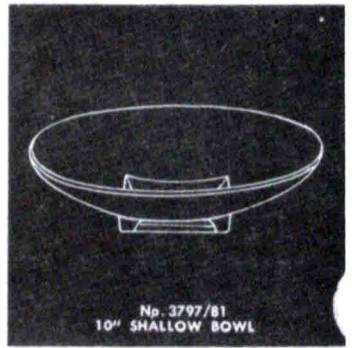

No. 3797/81
10" SHALLOW BOWL



THE CAMBRIDGE GLASS COMPANY, CAMBRIDGE, OHIO, U.S.A.



No. 3797/495
3 3/4" SQUARE CANDLESTICK

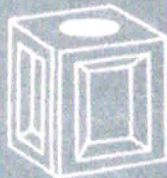

No. 3797/493
2 3/4" SQUARE CANDLESTICK



No. 3797/492
1 3/4" SQUARE CANDLESTICK



No. 3797/164 - 7" BONBON

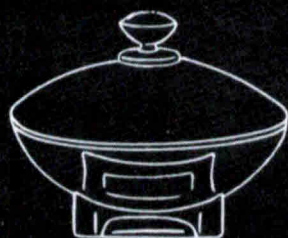

No. 3797/165
CANDY BOX AND COVER

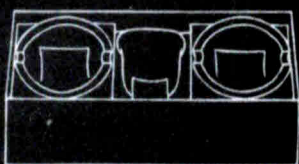

No. 3797/152
3-PIECE SMOKER SET



No. 3797/476
11 1/2" PUNCH BOWL

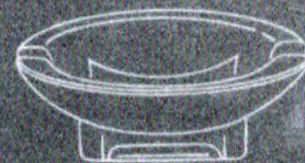

No. 3797/150 - 6 1/2" ASH TRAY

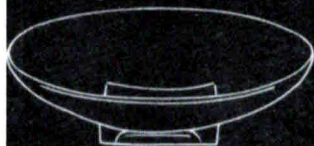

No. 3797/82
12" SHALLOW BOWL

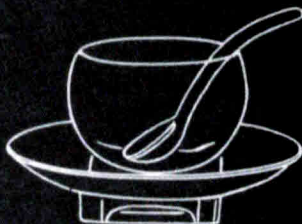

No. 3797/129
3-PIECE MAYONNAISE SET

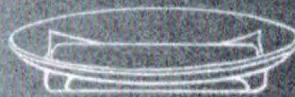

No. 3797/37 - 8" OVAL TRAY



No. 3797/151 - 3 1/2" ASH TRAY



No. 3797/78
9 1/4" FOOTED VASE



No. 3797/57
11" SALAD BOWL

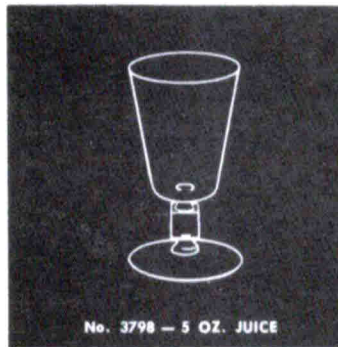
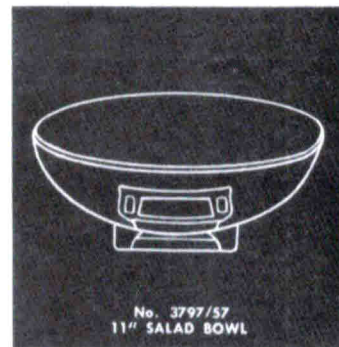
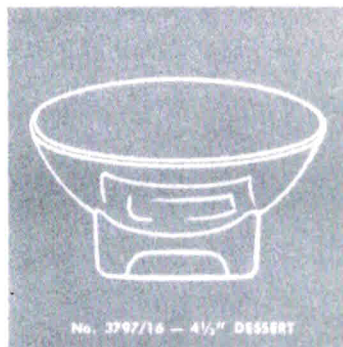
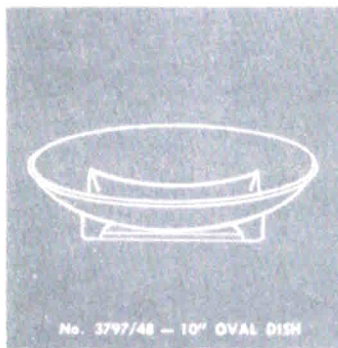

Cambridge
Square



THE CAMBRIDGE GLASS COMPANY, CAMBRIDGE, OHIO, U. S. A.

Cambridge Square

No. 3798 — 12 OZ. ICE TEA



No. 3798 — GOBLET



No. 3798 — SHERBET



No. 3798 — COCKTAIL



No. 3798 — CORDIAL

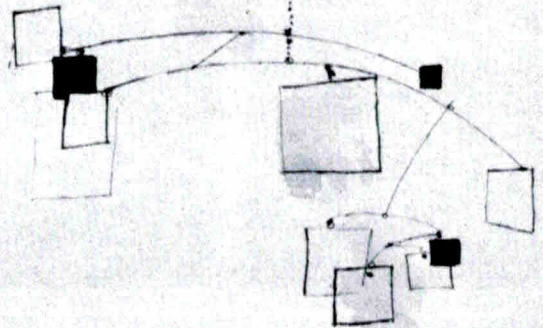

Cambridge Square

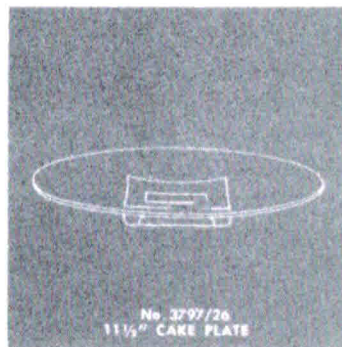
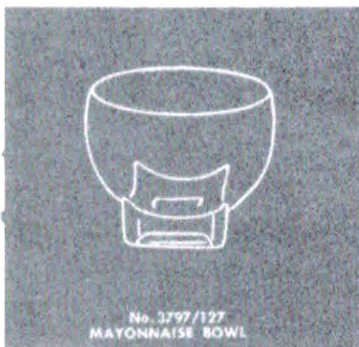
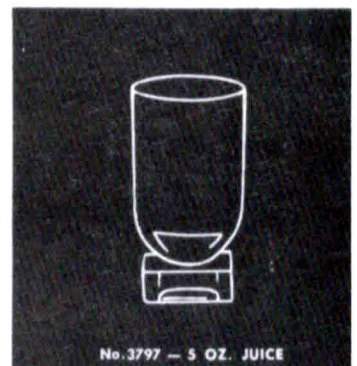

THE CAMBRIDGE GLASS COMPANY, CAMBRIDGE, OHIO, U. S. A.

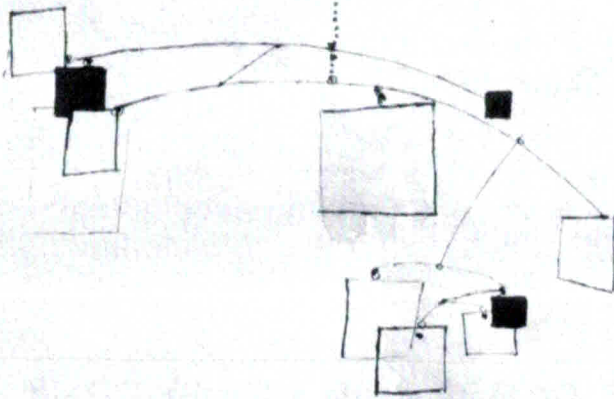
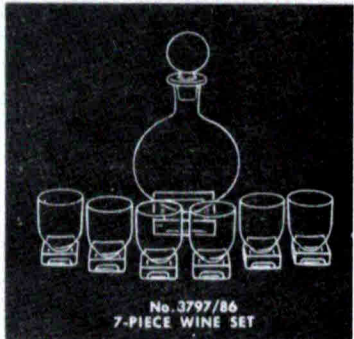
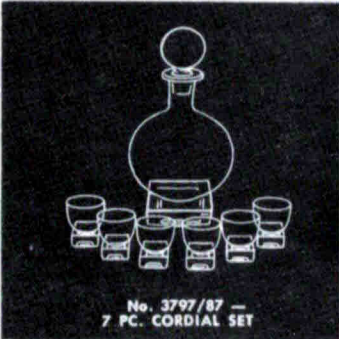
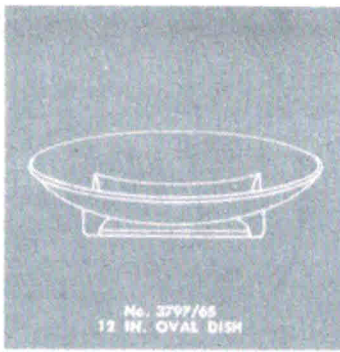
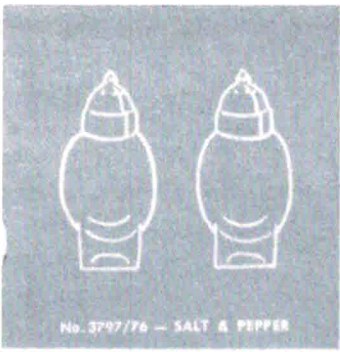

Cambridge Square



THE CAMBRIDGE GLASS COMPANY, CAMBRIDGE, OHIO, U. S. A.

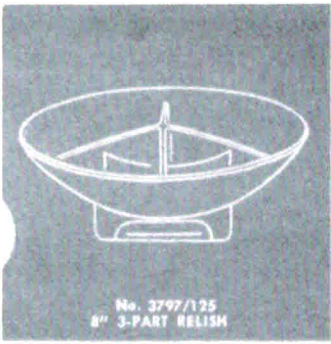

No. 3797/125
8" 3-PART RELISH



No. 3797/27
6 1/2" SALAD BOWL

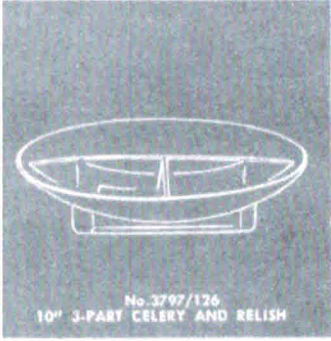

No. 3797/126
10" 3-PART CELERY AND RELISH

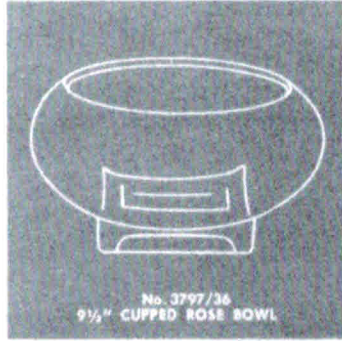

No. 3797/36
9 1/2" CUPPED ROSE BOWL

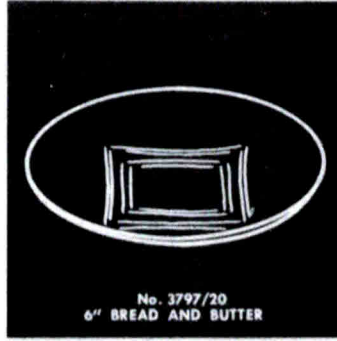

No. 3797/20
6" BREAD AND BUTTER

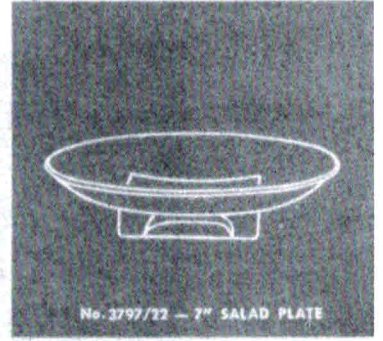

No. 3797/22 - 7" SALAD PLATE



No. 3797/35
7 1/2" CUPPED ROSE BOWL

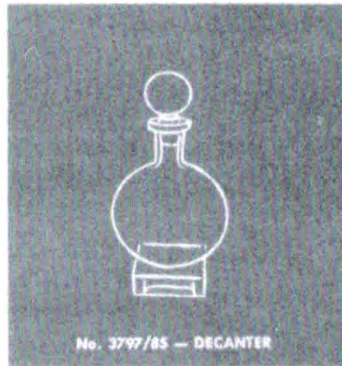

No. 3797/85 - DECANTER

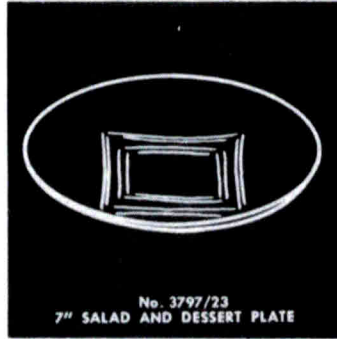

No. 3797/23
7" SALAD AND DESSERT PLATE

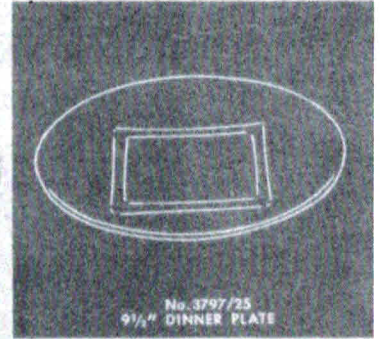

No. 3797/25
9 1/4" DINNER PLATE



No. 3797/47 - 8" BONBON



No. 3797/40
IND. SUGAR AND CREAM



No. 3797/41
SUGAR AND CREAM

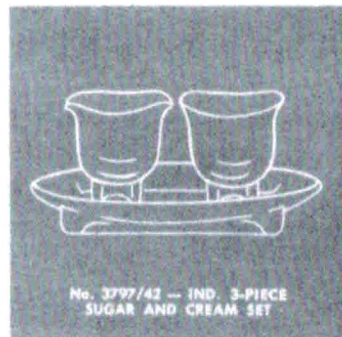

No. 3797/42 - IND. 3-PIECE
SUGAR AND CREAM SET

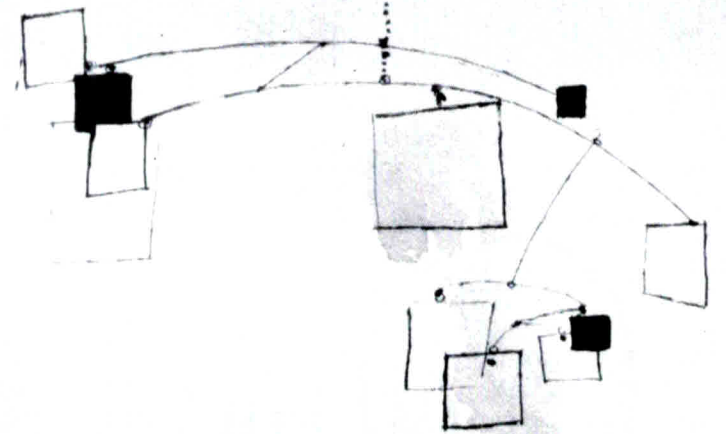



No. C-300 — LOW SHERBET



No. C-300 — CLARET



No. C-300
10 OZ. FOOTED TUMBLER



No. C-300 — WINE



No. C-300 — LOW COCKTAIL



No. C-300
5 OZ. FOOTED TUMBLER



No. C-300 — CORDIAL



No. C-300/2
12 OZ. ICE TEA, STEMMED

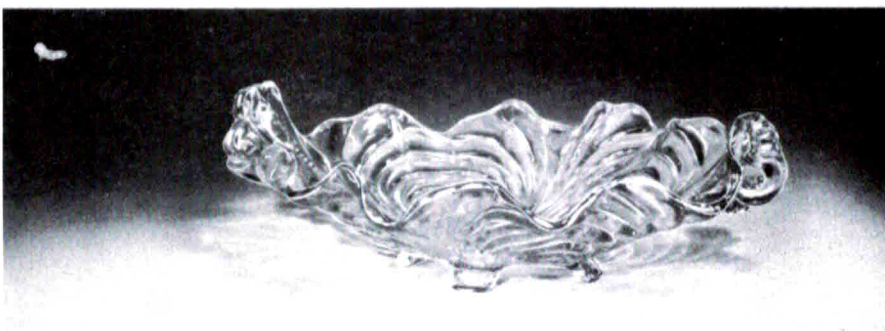

No. C-66
13" CRIMPED BOWL, 4 FOOTED



No. C-301 — CORDIAL

Caprice



No. C-301 — 12 OZ. ICE TEA

No. C-300 — GOBLET



No. C-300 — COCKTAIL



No. C-301 — GOBLET



No. C-300 — TALL SHERBET



No. C-301 — SHERBET



No. C-301 — COCKTAIL



No. C-301 — WINE



No. C-301 — CLARET



No. C-301 — 5 OZ. JUICE



No. C-301 — LOW COCKTAIL

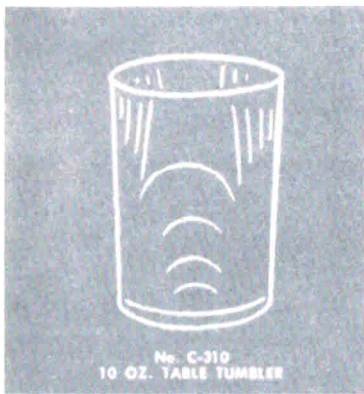

No. C-310
10 OZ. TABLE TUMBLER



No. C-310 — 12 OZ. ICE TEA

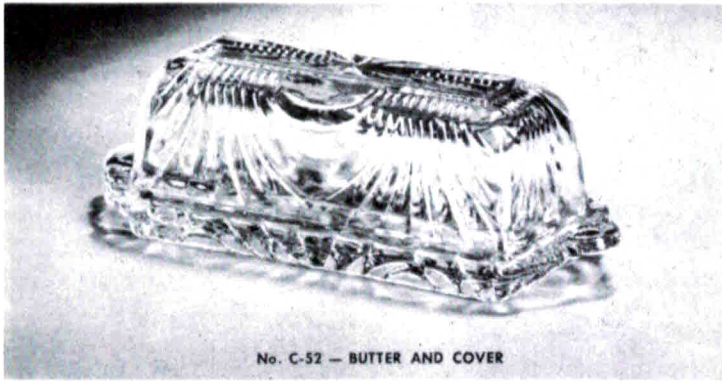

No. C-52 — BUTTER AND COVER



No. C-1338
3-LITE CANDLESTICK



No. C-647 — 2-LITE CANDLESTICK

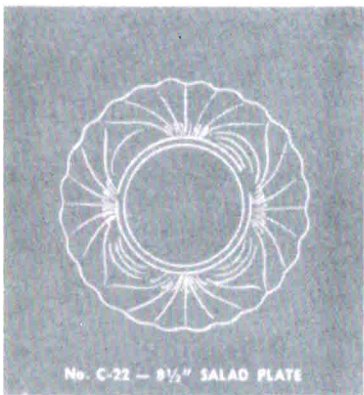

No. C-22 — 9 1/2" SALAD PLATE

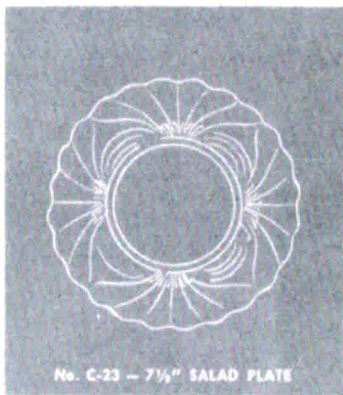

No. C-23 — 7 1/2" SALAD PLATE

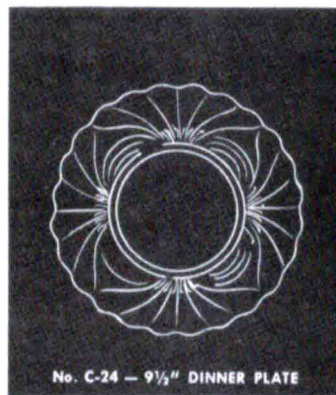

No. C-24 — 9 1/2" DINNER PLATE

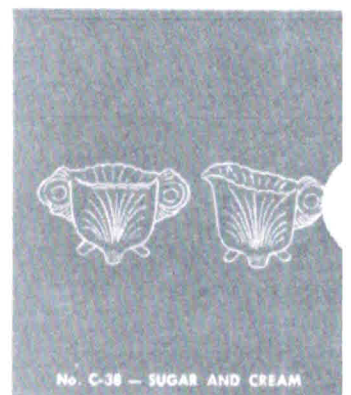

No. C-38 — SUGAR AND CREAM

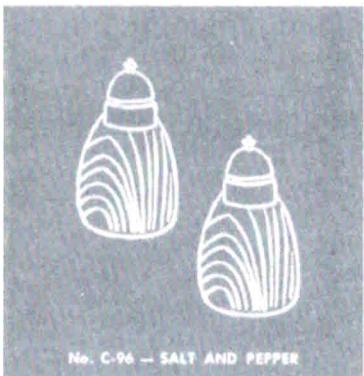

No. C-96 — SALT AND PEPPER



No. C-40
IND. SUGAR AND CREAM

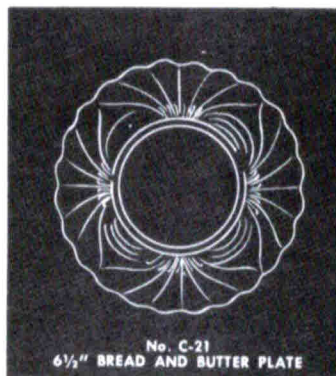

No. C-21
6 1/2" BREAD AND BUTTER PLATE



No. C-17 — CUP AND SAUCER



No. C-151 — 5" JELLY

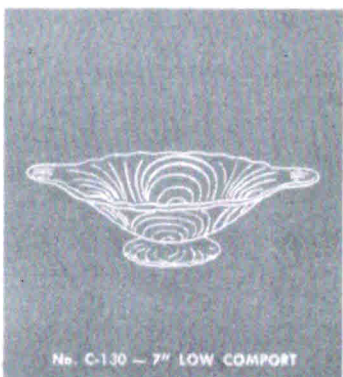

No. C-130 — 7" LOW COMFORT

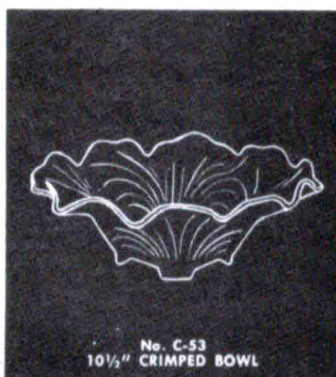

No. C-53
10 1/2" CRIMPED BOWL

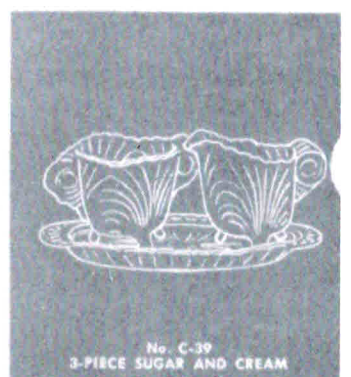

No. C-39
3-PIECE SUGAR AND CREAM

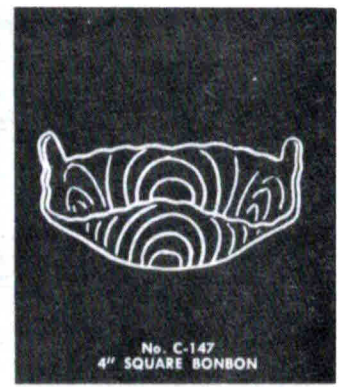
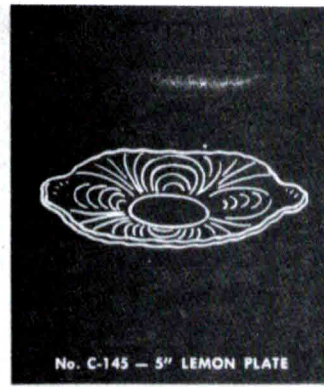

Caprice

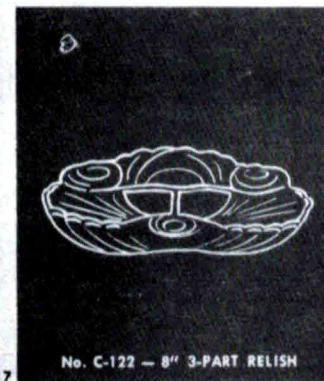
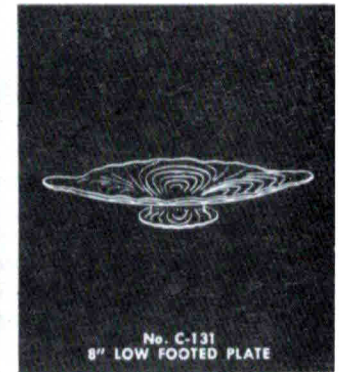
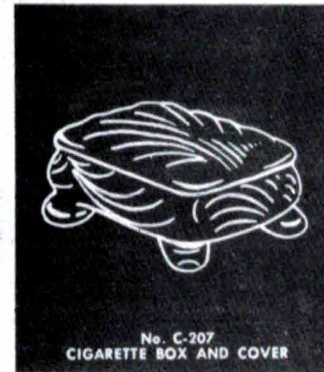
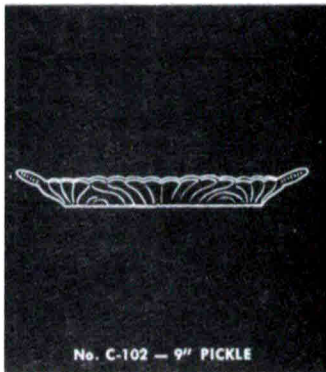
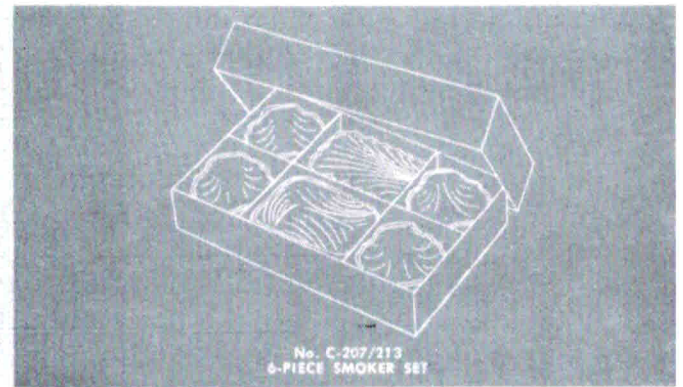
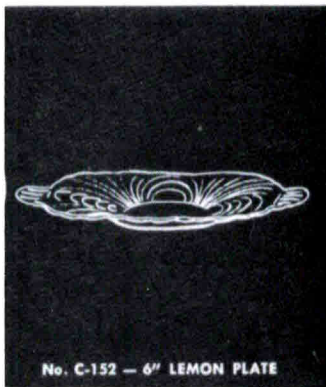
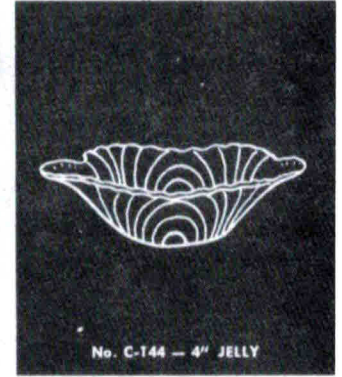

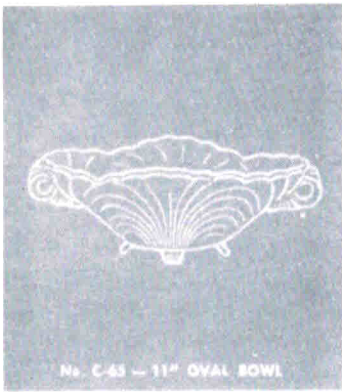

No. C-65 — 11" OVAL BOWL



No. C-117 — 3 OZ. OIL



No. C-67 — 2 1/2" CANDLESTICK



No. C-124 — 8 1/2" 3-PART
CELERY AND RELISH TRAY



No. C-13 — 3 1/2" COASTER



No. C-37 — 6" OVAL TRAY



No. C-28 — 14" PLATE



No. C-183 — 80 OZ. BALL JUG



No. C-120 — 2-PART RELISH



No. C-30 — 16" PLATE



No. C-81
11 1/2" SHALLOW BOWL



No. C-26 — 11 1/2" PLATE

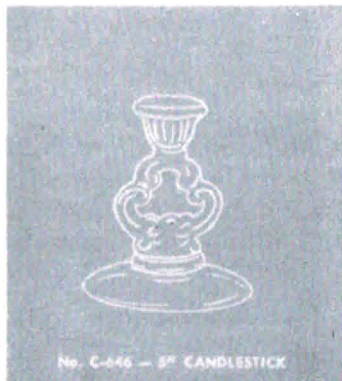

No. C-66 — 5" CANDLESTICK



No. C-129
3-PIECE MAYONNAISE SET



No. C-62 — 12 1/2" BELLED BOWL



No. C-87
13 1/2" SHALLOW BOWL



No. C-216 - 5" ASH TRAY

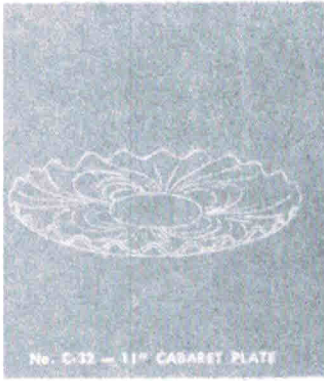

No. C-32 - 11" CABARET PLATE



No. C-214 - 3" ASH TRAY

Caprice



No. C-33 - 14" CABARET PLATE



No. C-213
2 3/4" ASH TRAY OR NUT CUP

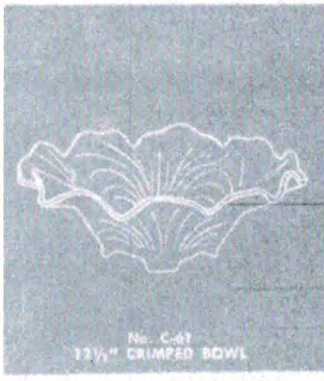

No. C-41
12 1/2" CRIMPED BOWL

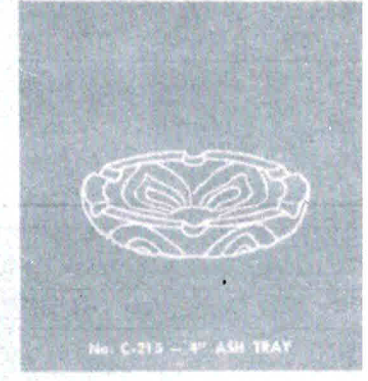

No. C-215 - 8" ASH TRAY



No. C-54 - 10 1/2" BEILED BOWL



No. C-145
CANDY BOX AND COVER

Corinth

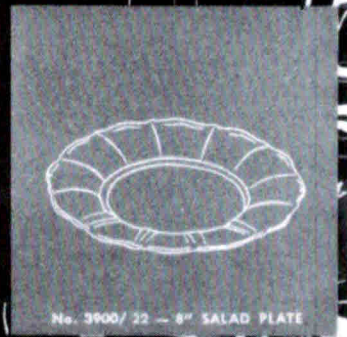
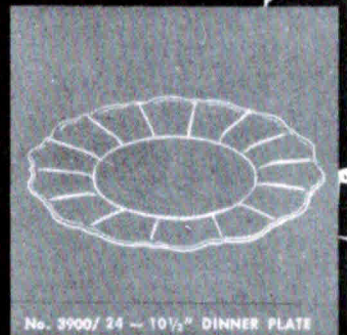
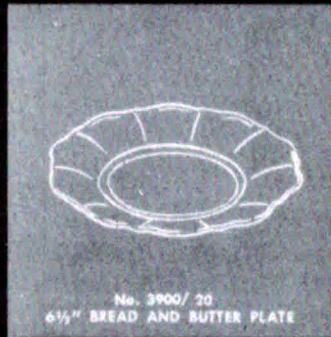

THE CAMBRIDGE GLASS COMPANY, CAMBRIDGE, OHIO, U.S.A.

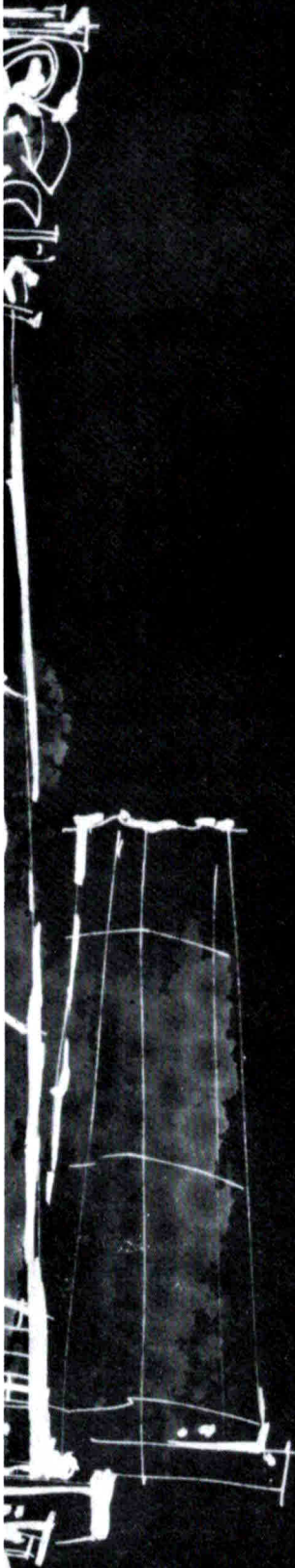

3900 — WINE



3900 — CLARET



3900
12 OZ. FOOTED ICE TEA



3900 — LOW SHERBET



3900
10 OZ. FOOTED TUMBLER



3900
5 OZ. FOOTED TUMBLER



3900 — CORDIAL

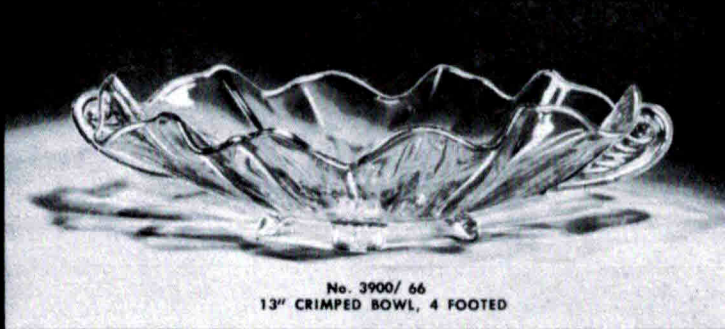

No. 3900/ 66
13" CRIMPED BOWL, 4 FOOTED



3900 — COMFORT

Orinth



No. 3900/125
9" 3-PART CELERY AND RELISH



No. 3900/126
12" 2-PART CELERY AND RELISH



No. 3900/129
3-PIECE MAYONNAISE SET

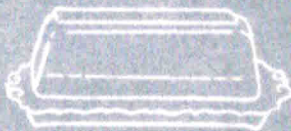

No. 3900/52 - 1/2 LB.
BUTTER AND COVER



No. 3900/130 - 7" BONBON



No. 3900/124 - 7" 2-PART RELISH



THE CAMBRIDGE GLASS COMPANY, CAMBRIDGE, OHIO, U. S. A.

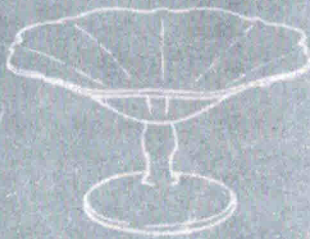
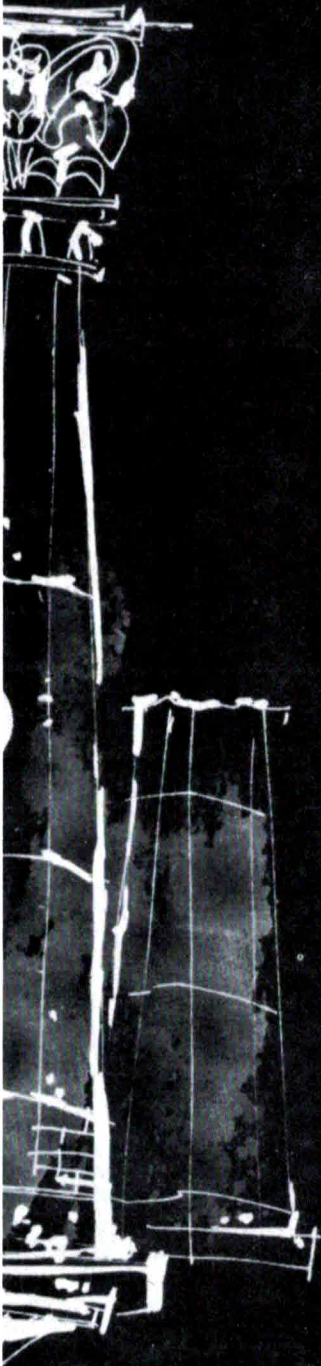

No. 3900/125 - 5" COMPOTE



No. 3900/115 - 76 OZ. JUG



No. 3900/35 - 13 1/2" CAKE PLATE



No. 3900/136 - 2 1/2" COMPOTE



No. 3900/166 - 14" PLATE

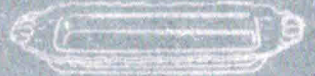

No. 3900/37
SUGAR AND CREAM TRAY



No. 3900/111
4-PIECE MAYONNAISE SET



No. 3900/36 - 12" FOOTED PLATE



No. 3900/38 IND.
2-PIECE SUGAR AND CREAM SET



No. 3900/120
1/2" 5-PART CELERY AND RELISH



No. 3900/32
13" FOOTED TORTE PLATE



No. 3900/39
2-PIECE SUGAR AND CREAM SET



No. 3900/114
32 OZ. MARTINI JUG



No. 3900/123
ICE BUCKET WITH HANDLE



No. 3900/118 - 32 OZ. JUG

Orinth



No. 3906/12
3-PIECE COCKTAIL ICE



No. 3906/14
2-PIECE HIGHBALL SET

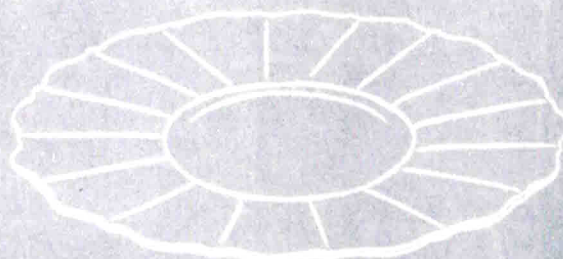

No. 3906/167 - 14" PLATE



No. 3906/12
12" OVAL SET



No. 3906/40
TWO, SUGAR AND CREAM



No. 3906/41 - SUGAR AND CREAM



THE CAMBRIDGE GLASS COMPANY, CAMBRIDGE, OHIO, U.S.A.

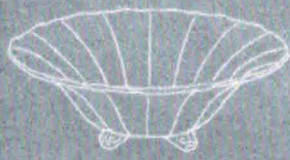

No. 3900/54 — 10" FOOTED BOWL

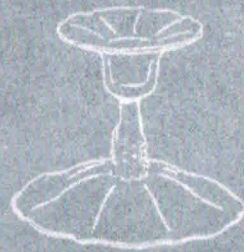

No. 3900/69 — 3" CANDLESTICK



No. 3900/72
6" 2-LITE CANDLESTICK



No. 3900/125
13 1/2" CHEESE AND CRACKER



No. 3900/115 — 13 OZ. TUMBLER



No. 3900/117 — 5 OZ. TUMBLER



No. 3900/74
6" 3-LITE CANDLESTICK

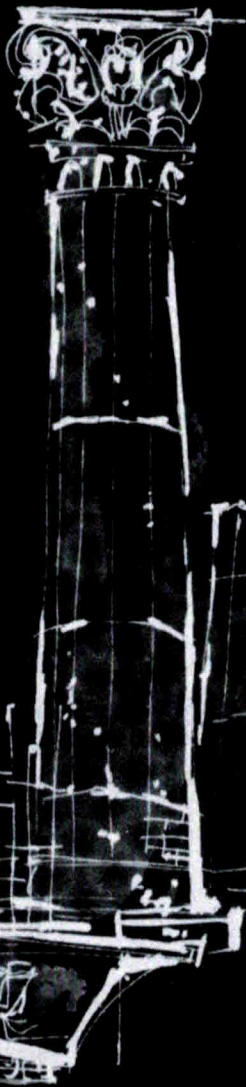

No. 3900/117 — 20 OZ. JUG



No. 3900/100 — 6 OZ. OIL



No. 3900/75 — EPERGNE

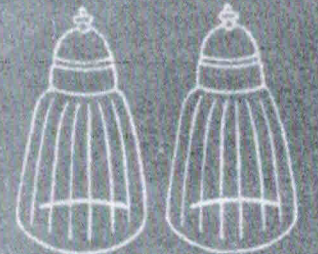

No. 3900/1177 — SALT AND PEPPER



No. 3900/131 — 8" BONBON PLATE



No. 3900/165
CANDY BOX AND COVER

Pristine

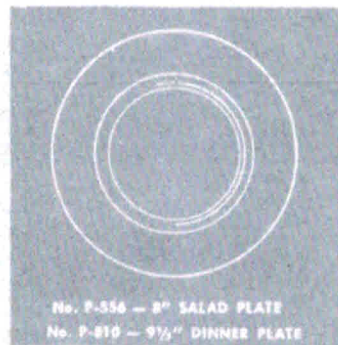
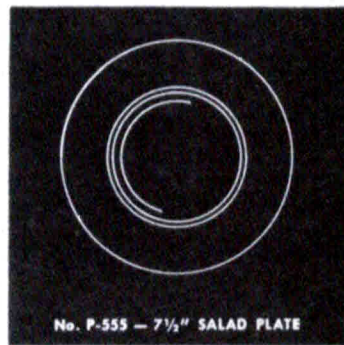
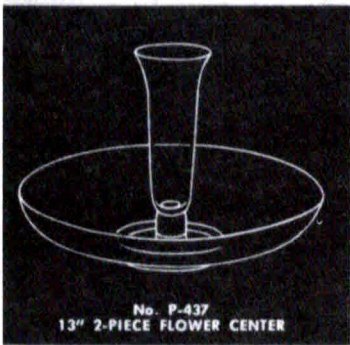

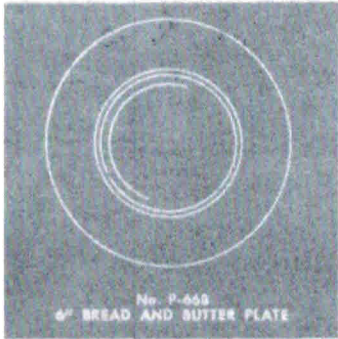

No. P-658
6" BREAD AND BUTTER PLATE



No. P-933 - CUP AND SAUCER

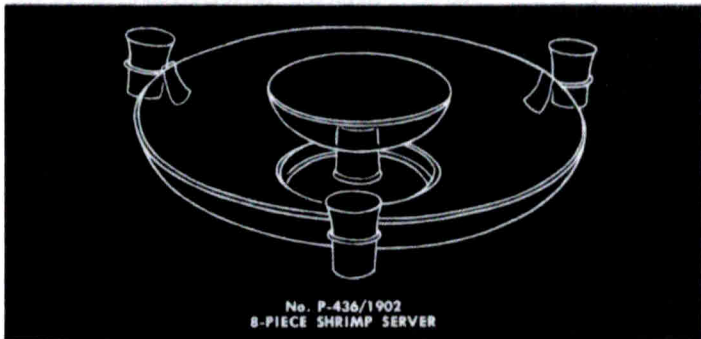

No. P-436/1902
8-PIECE SHRIMP SERVER

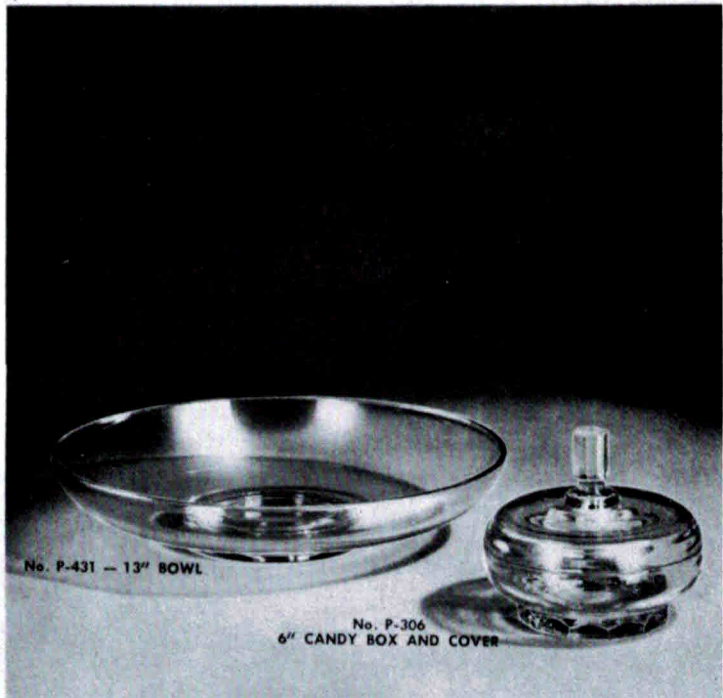

No. P-431 - 13" BOWL

No. P-306
6" CANDY BOX AND COVER



THE CAMBRIDGE GLASS COMPANY, CAMBRIDGE, OHIO, U. S. A.



No. P-381 — 8 1/4" RIM SOUP

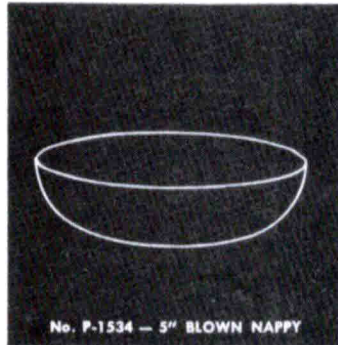

No. P-1534 — 5" BLOWN NAPPY

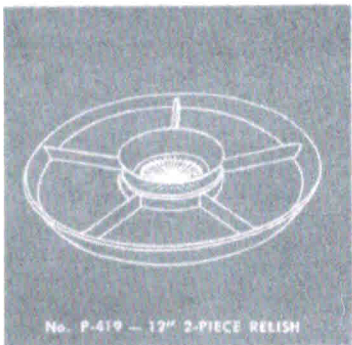

No. P-419 — 12" 2-PIECE RELISH

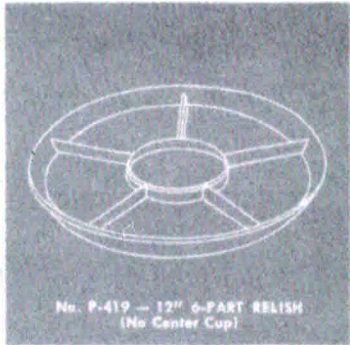

No. P-419 — 12" 6-PART RELISH
(No Center Cup)



No. P-419 — SAUCE CUP



No. P-207
8" 3-PART RELISH TRAY

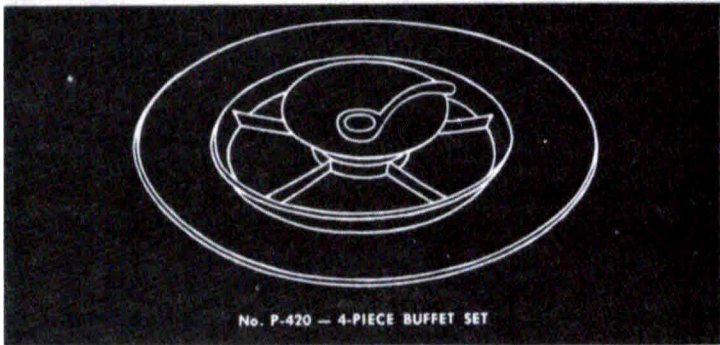

No. P-420 — 4-PIECE BUFFET SET



No. P-1535 — 6 1/2" BLOWN NAPPY

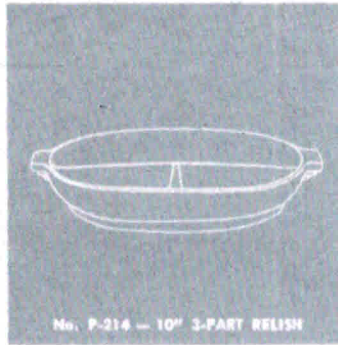

No. P-214 — 10" 3-PART RELISH

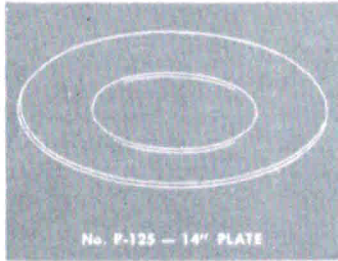

No. P-125 — 14" PLATE

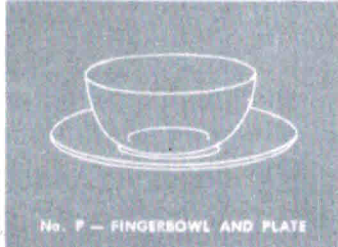

No. P — FINGERBOWL AND PLATE

Pristine

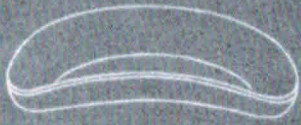

No. P-454 — CRESCENT SALAD PLATE

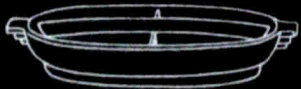

No. P-212 — 10" 5-PART
CELERY & RELISH TRAY



No. P-466 — 6 1/2" BAKED APPLE



No. P-1498 — 8" 3-PART RELISH



No. P-101
32 OZ. COCKTAIL SHAKER

No. P-604 — 8" BUD VASE

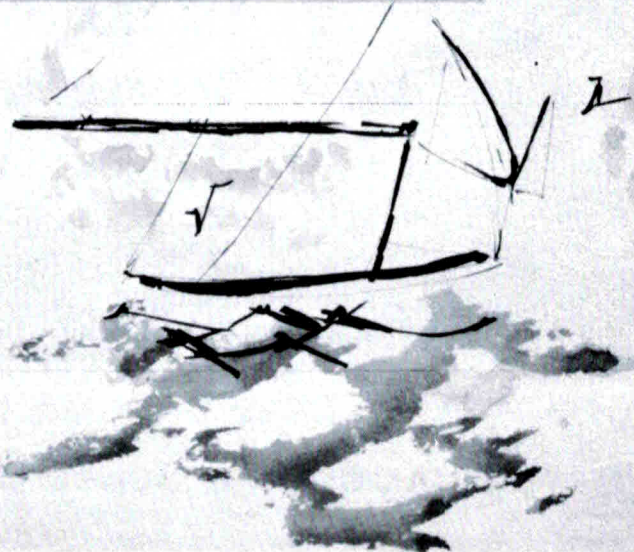

Pristine

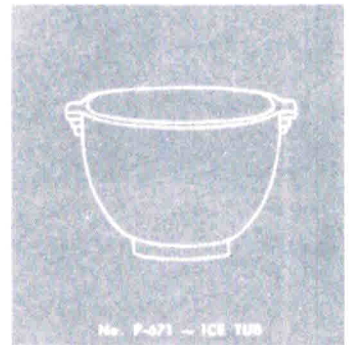

THE CAMBRIDGE GLASS COMPANY, CAMBRIDGE, OHIO, U.S.A.

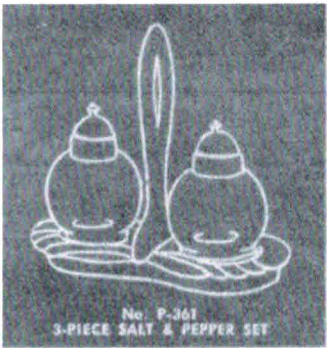

No. P-361
3-PIECE SALT & PEPPER SET

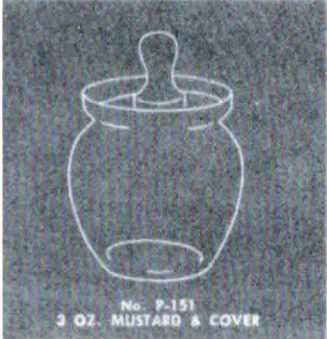

No. P-151
3 OZ. MUSTARD & COVER

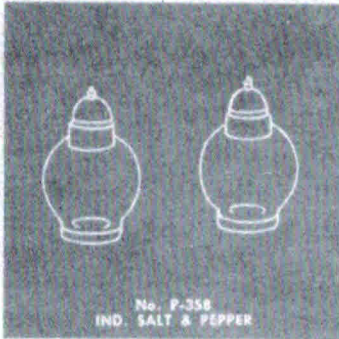

No. P-358
IND. SALT & PEPPER

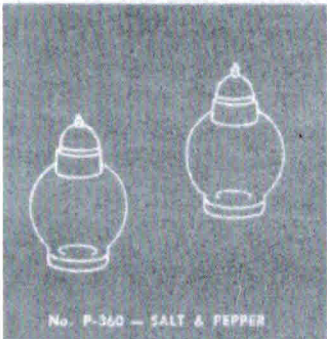

No. P-360 - SALT & PEPPER



No. P-147
8 OZ. MARMALADE & COVER



No. P-126 - 13 1/2" GARDENIA BOWL

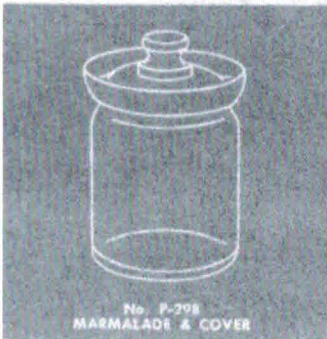

No. P-208
MARMALADE & COVER

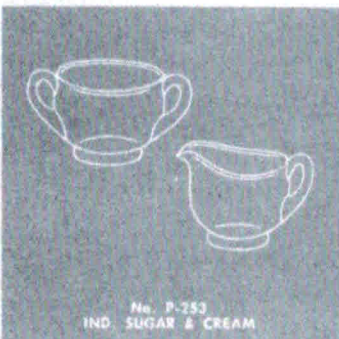

No. P-253
IND. SUGAR & CREAM

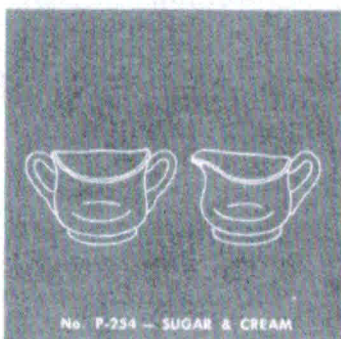

No. P-254 - SUGAR & CREAM

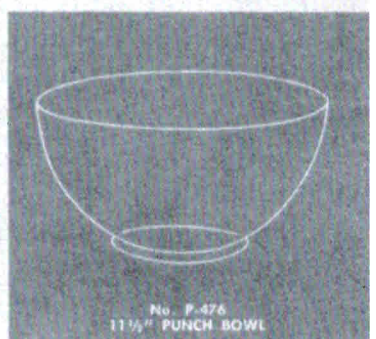

No. P-476
11 1/2" PUNCH BOWL

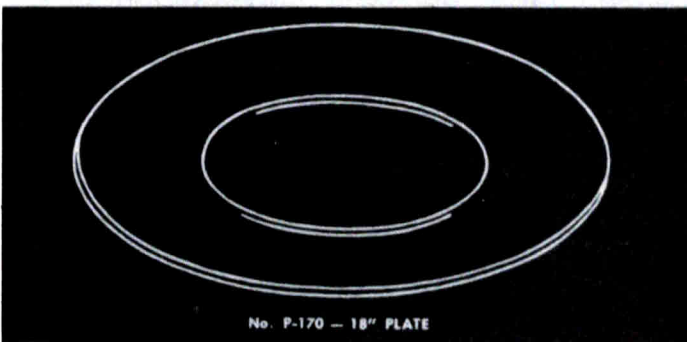

No. P-170 - 18" PLATE

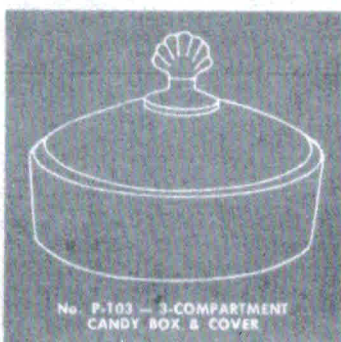

No. P-103 - 3-COMPARTMENT
CANDY BOX & COVER

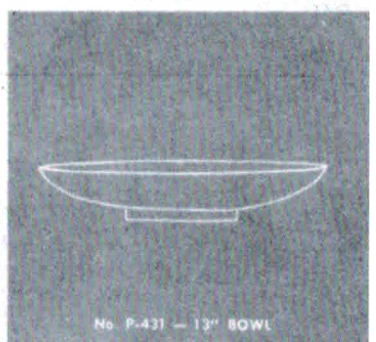

No. P-431 - 13" BOWL

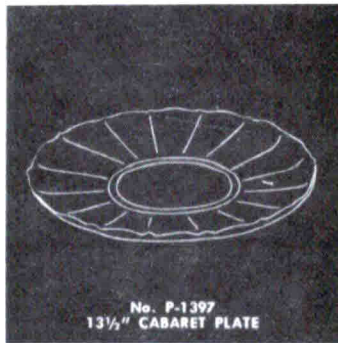

No. P-1397
13 1/2" CABARET PLATE

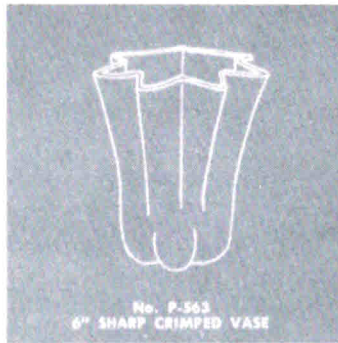

No. P-563
6" SHARP CRIMPED VASE

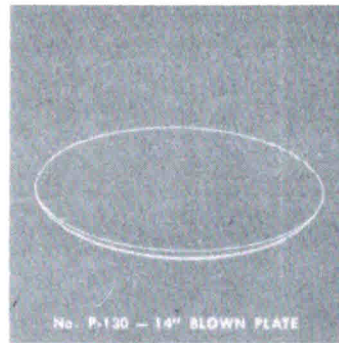

No. P-130 - 14" BLOWN PLATE

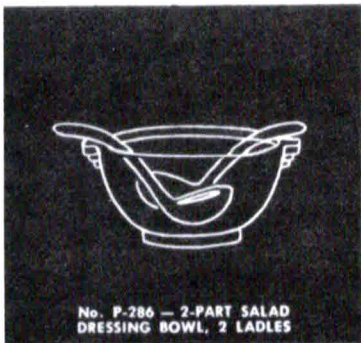

No. P-286 - 2-PART SALAD
DRESSING BOWL, 2 LADLES

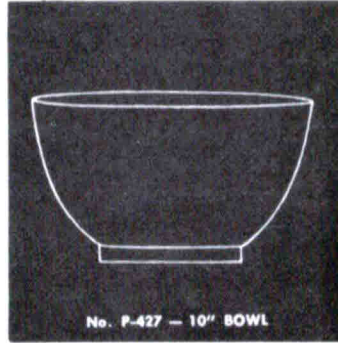

No. P-427 - 10" BOWL

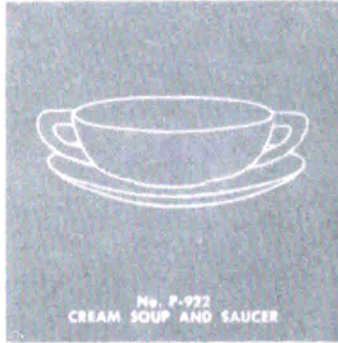

No. P-922
CREAM SOUP AND SAUCER

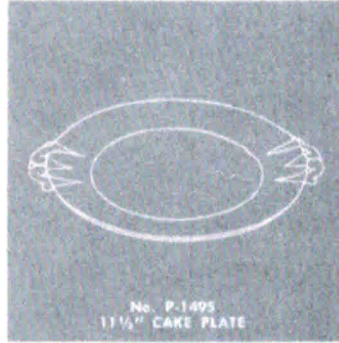

No. P-1495
11 1/2" CAKE PLATE



No. P-565 - CRIMPED VASE



No. P-569 - 9" CRIMPED VASE



No. P-430 - 12" BELLED BOWL



No. 3700 - 5" COMFORT

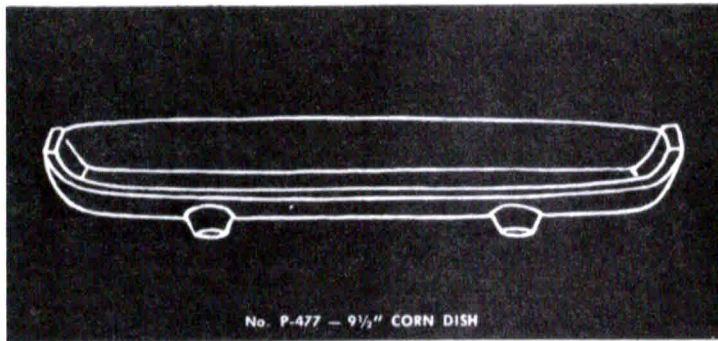

No. P-477 - 9 1/2" CORN DISH

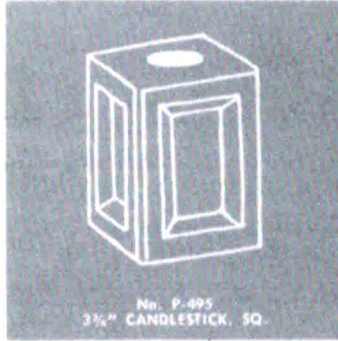

No. P-495
3 1/4" CANDLESTICK, SQ.

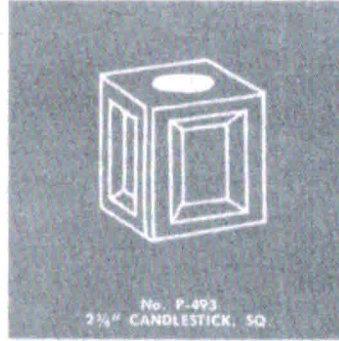

No. P-493
2 3/4" CANDLESTICK, SQ.

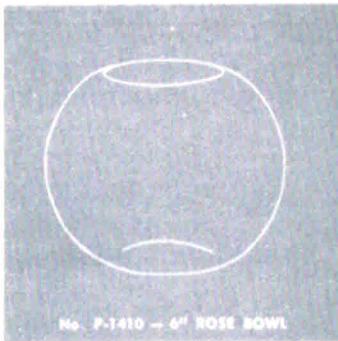

No. P-1410 - 4" ROSE BOWL

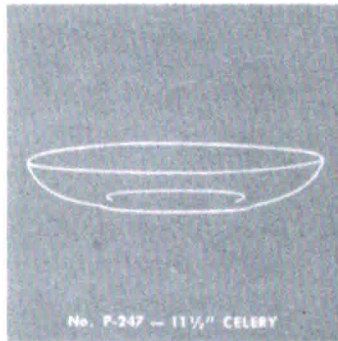

No. P-247 - 11 1/2" CELERY

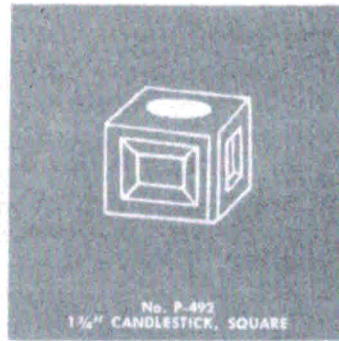

No. P-492
1 3/4" CANDLESTICK, SQUARE



THE CAMBRIDGE GLASS COMPANY, CAMBRIDGE, OHIO, U. S. A.

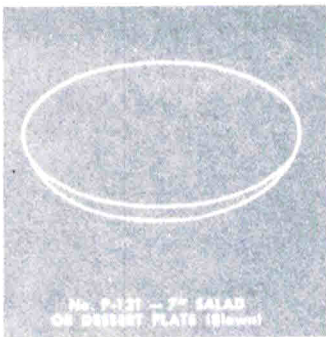

No. P-121 - 7" SALAD OR DESSERT PLATE (16) oval



No. P-282 4-PIECE SALAD DRESSING SET

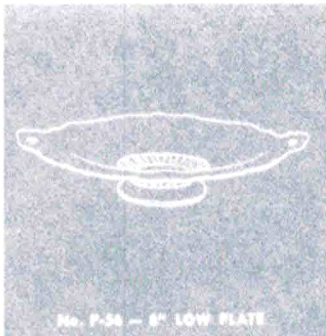

No. P-54 - 8" LOW PLATE

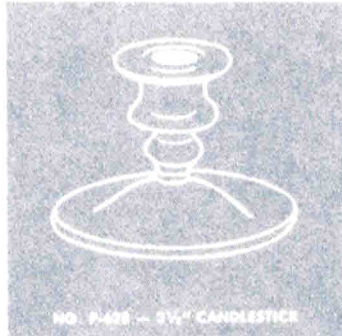

NO. P-425 - 2 1/4" CANDLESTICK

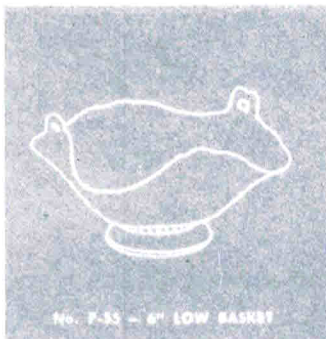

No. P-55 - 6" LOW BASKET

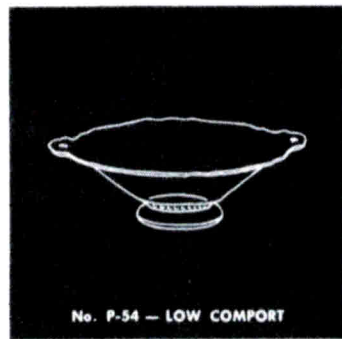

No. P-54 - LOW COMPORT

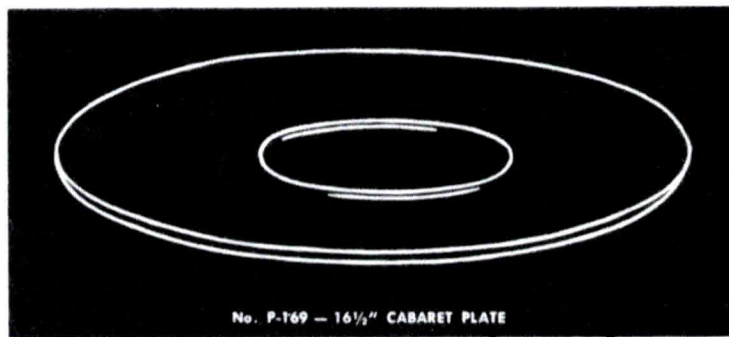

No. P-T69 - 16 1/2" CABARET PLATE



No. P-48 - SAUCE CUP



No. P-T66 12 1/2" CABARET PLATE

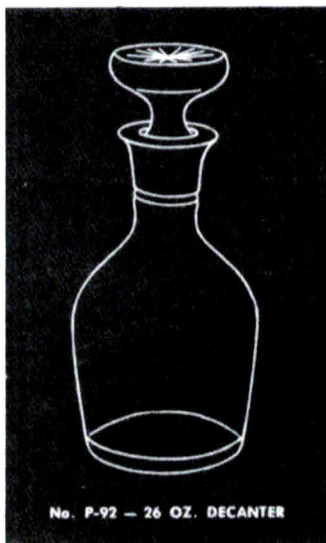

No. P-92 - 26 OZ. DECANTER

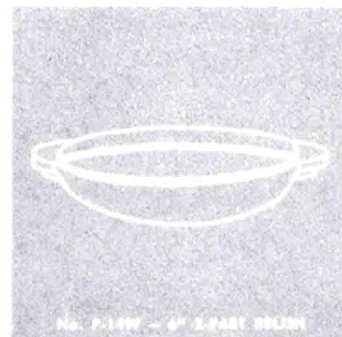

No. P-147 - 6" 3-PART BOWL



Pristine

Pristine



No. P-568
6" CRIMPED, OBLONG, VASE

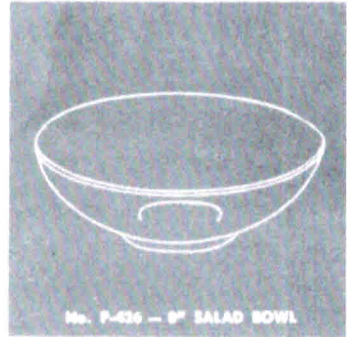

No. P-436 - 8" SALAD BOWL

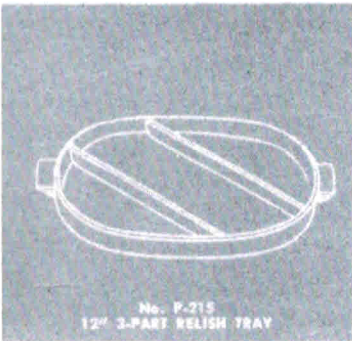

No. P-215
12" 3-PART RELISH TRAY

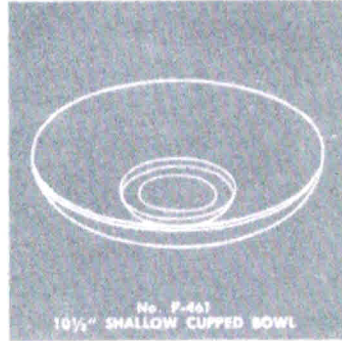

No. P-461
10 1/4" SHALLOW CUPPED BOWL

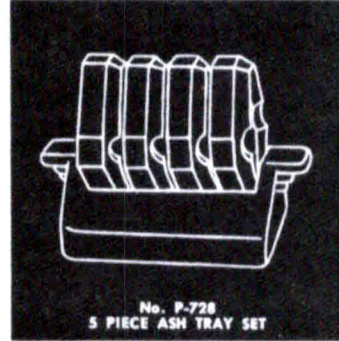

No. P-728
5 PIECE ASH TRAY SET

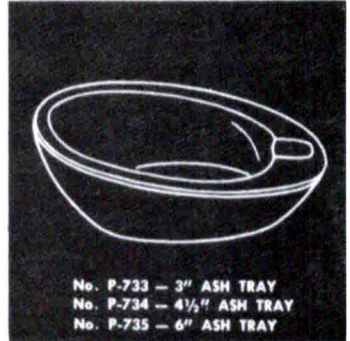

No. P-733 - 3" ASH TRAY
No. P-734 - 4 1/2" ASH TRAY
No. P-735 - 6" ASH TRAY

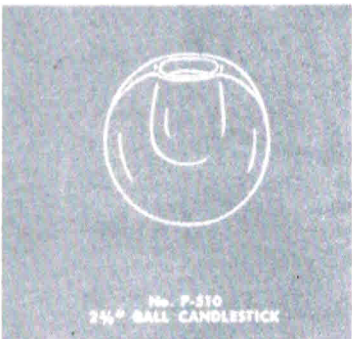

No. P-210
2 1/2" BALL CANDLESTICK



No. P-306
4" CANDY BOX AND COVER



No. P-572 - 8" VASE

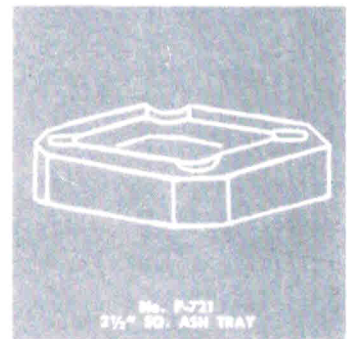

No. P-721
2 1/2" SQ. ASH TRAY

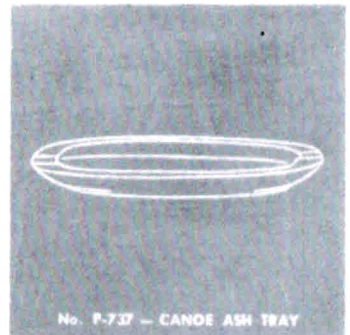

No. P-737 - CANOE ASH TRAY



THE CAMBRIDGE GLASS COMPANY, CAMBRIDGE, OHIO, U. S. A.

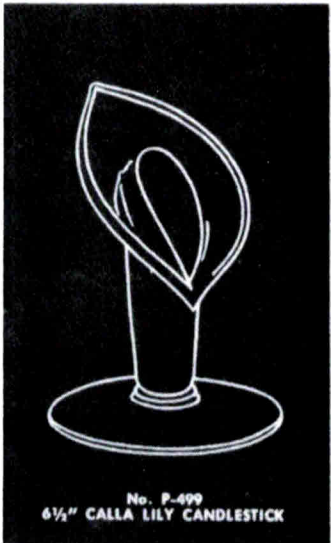
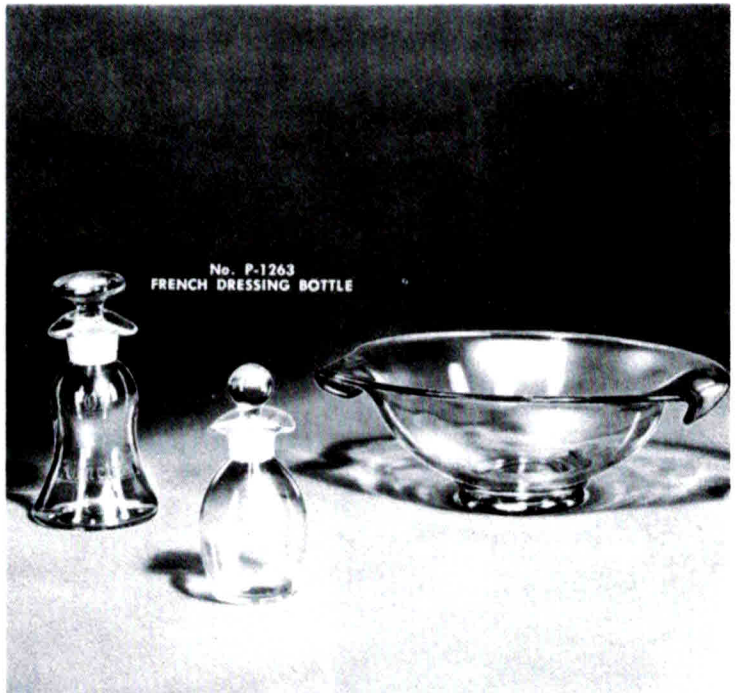
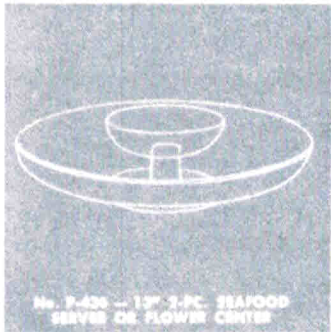
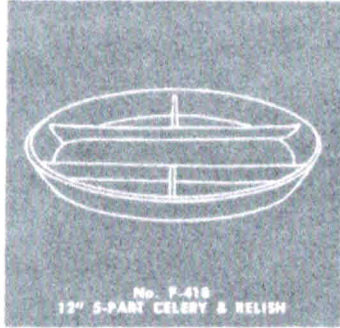



No. 1957 — SHERBET



No. 1957 — COCKTAIL

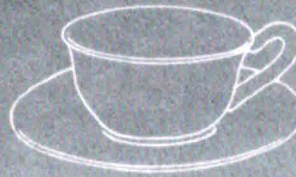

No. 1957/110 — CUP & SAUCER



No. 1957/127 — 3 PC.
MAYONNAISE SET



No. 1957 — DECANTER

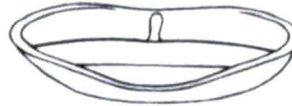

No. 1957/116 — CELERY & RELISH

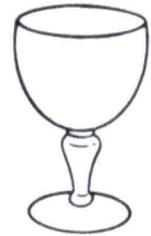

No. 1957 — WINE

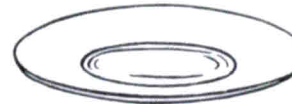

No. 1957/33
15" TORTE PLATE

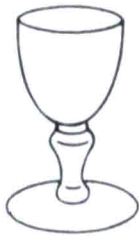

No. 1957 — CORDIAL



No. 1957/117
CELERY



No. 1957/41 — SUGAR & CREAM



No. 1957/115 — SALAD PLATE
No. 1957/114 — 10 IN. DINNER PLATE



No. 1957 — ICE TEA



No. 1957 — 5 OZ. FTD.

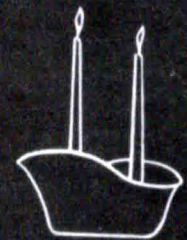

No. 1957/120
2-LITE CANDLESTICK



THE CAMBRIDGE GLASS COMPANY, CAMBRIDGE, OHIO, U.S.A.

Sonata the oval line

These items are also made . . .

- No. 1957/110 — OVAL CUP AND SAUCER
- No. 1957/113 — 10" PLATE WITH SEAT FOR No. 110 CUP
- No. 1957/117 — OVAL CELERY AND RELISH
- No. 1957/121 — 1-LITE CANDLESTICK

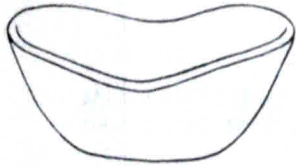

No. 1957/124 — BONBON

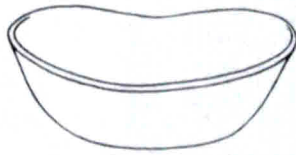

No. 1957/101
SMALL OVAL BOWL

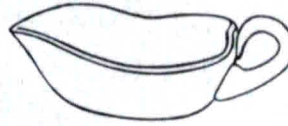

No. 1957/129 — HDL. SAUCE BOAT

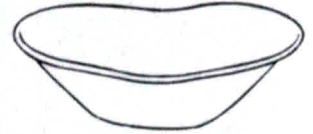

No. 1957/100
10" OVAL BOWL

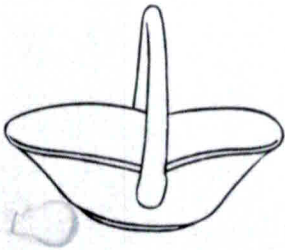

No. 1957/131 — HDL. BASKET

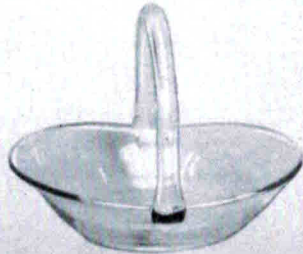

No. 1957/132 — HDL. BASKET

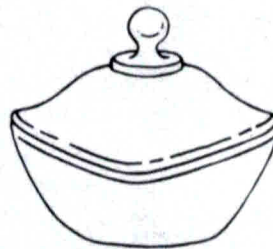

No. 1957/130
SWEET DISH & COVER

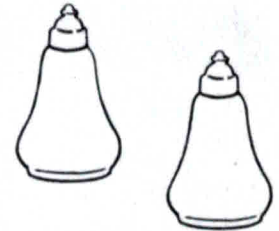

No. 1957/112 — SALT & PEPPER



No. 1957/135 — OIL



No. 1957 — MARTINI SWIRLER



No. 1957 — GOBLET

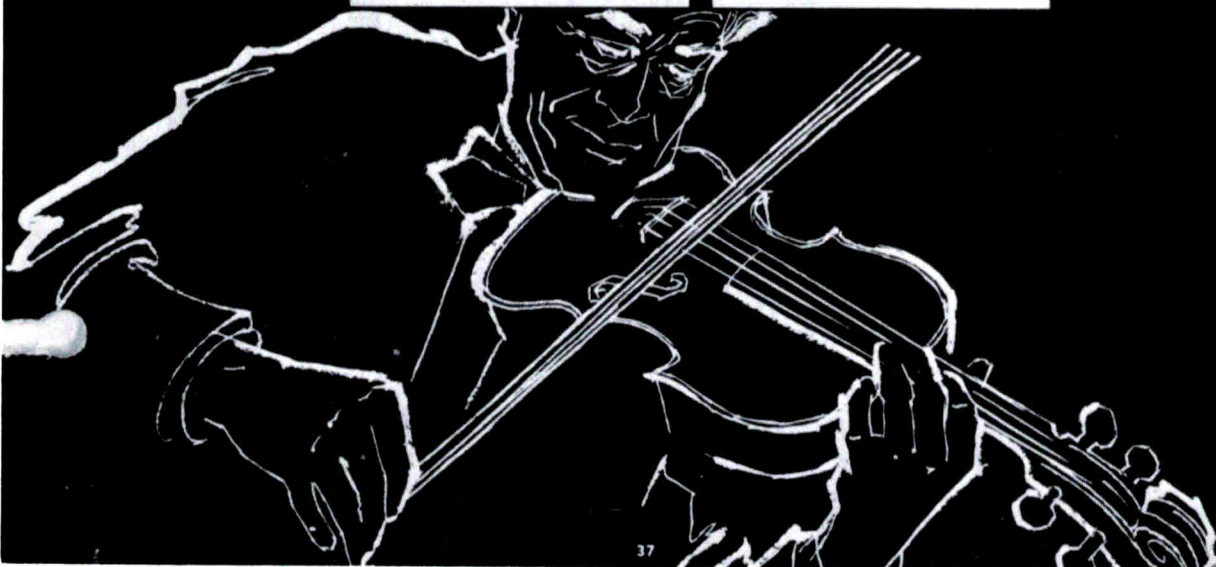



**No. 1957 GOBLET — CHARM
ROCK CRYSTAL ENGRAVED**



**No. 1957 GOBLET — SPRING
ROCK CRYSTAL ENGRAVED**

Georgian Line

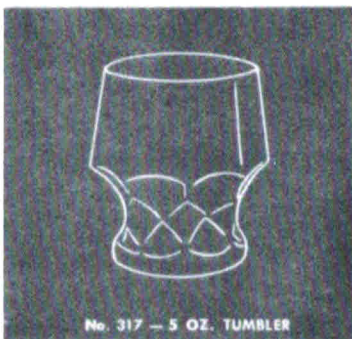
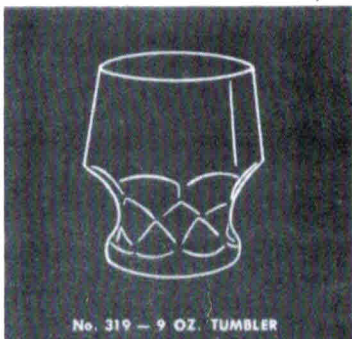

Gifts

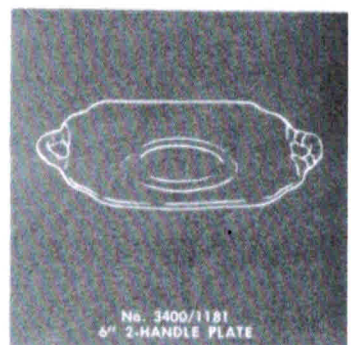
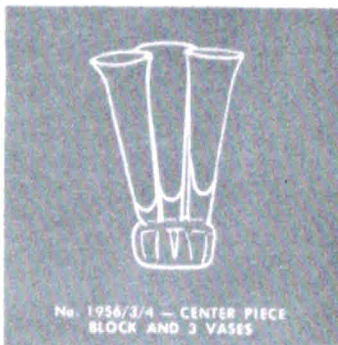
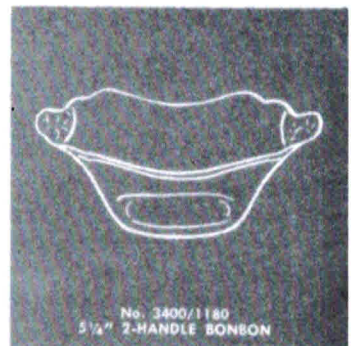
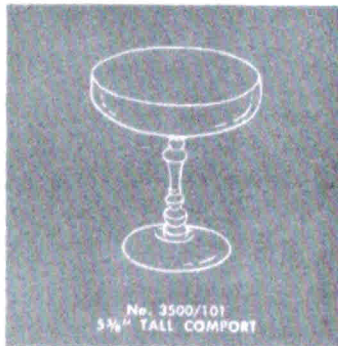

THE CAMBRIDGE GLASS COMPANY, CAMBRIDGE, OHIO, U. S. A.

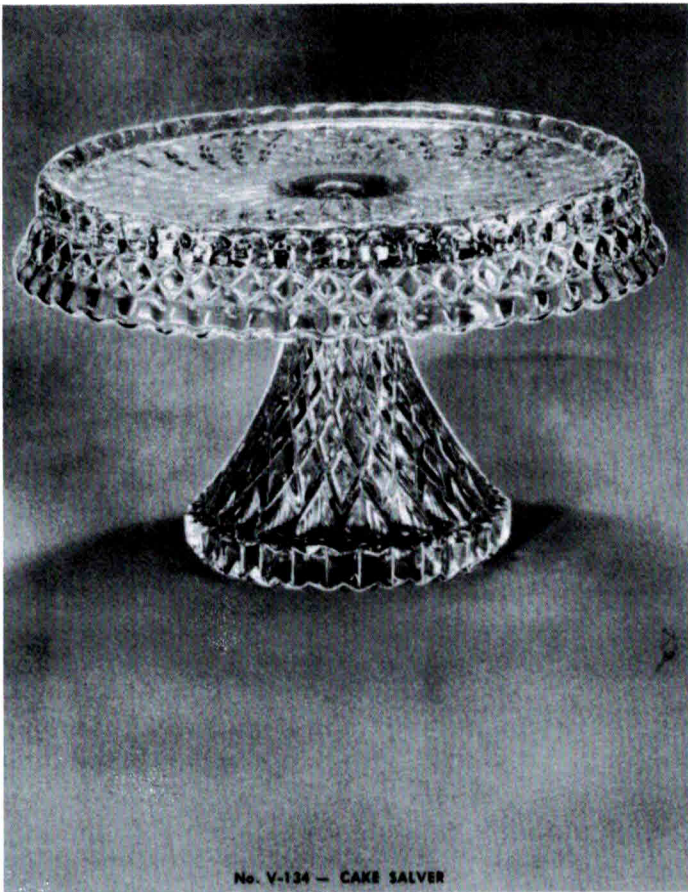

No. V-134 — CAKE SALVER



No. 3121/1
5 3/4" TALL COMFORT



No. 3900/126
CELERY AND RELISH



No. 7801 — 4 OZ. COCKTAIL



No. 7801
5 OZ. WHISKEY SOUR



No. 7801
1 OZ. POUSSE CAFE



No. 3011/25 — IVY BALL

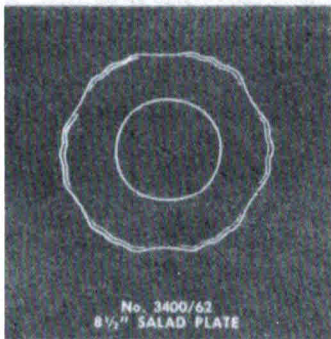

No. 3400/62
8 1/2" SALAD PLATE

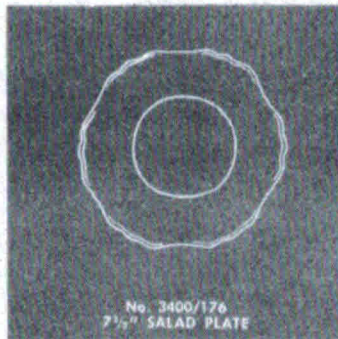

No. 3400/176
7 1/2" SALAD PLATE

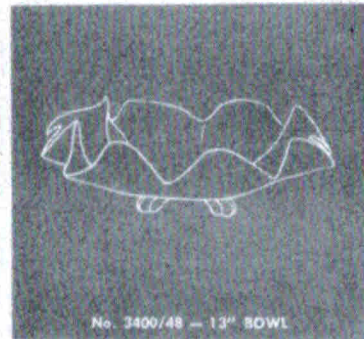

No. 3400/48 — 13" BOWL



No. 3011/9 — COCKTAIL

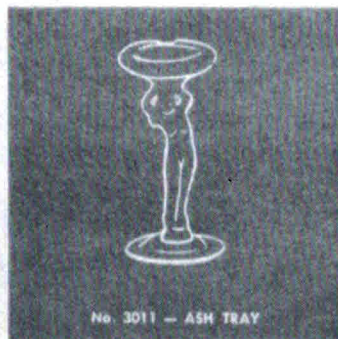

No. 3011 — ASH TRAY



No. 3400/160
12" OBLONG BOWL

Gifts

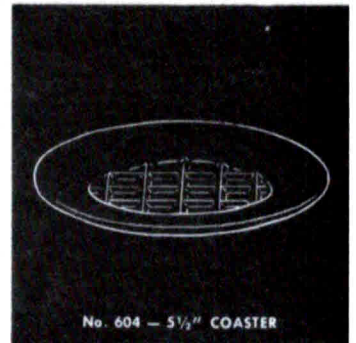
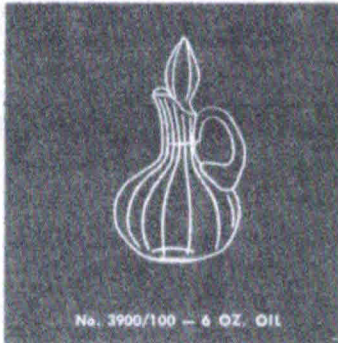
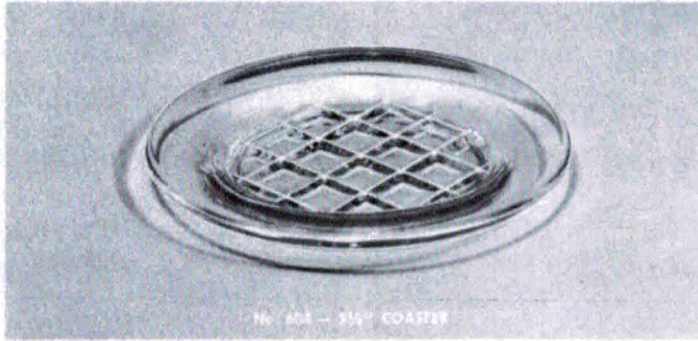
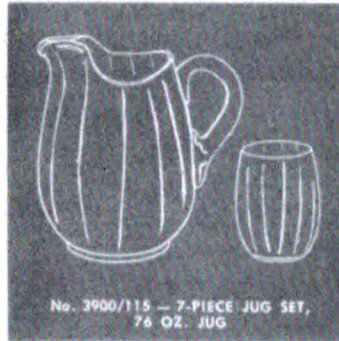
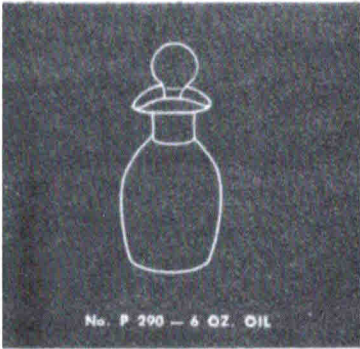

THE CAMBRIDGE GLASS COMPANY, CAMBRIDGE, OHIO, U. S. A.



No. M-157
DEVILED EGG PLATE

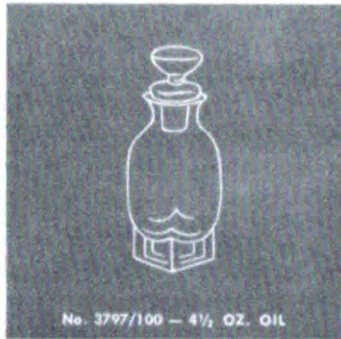

No. 3797/100 — 4 1/2 OZ. OIL



No. 3797/18
2-PIECE COCKTAIL ICER

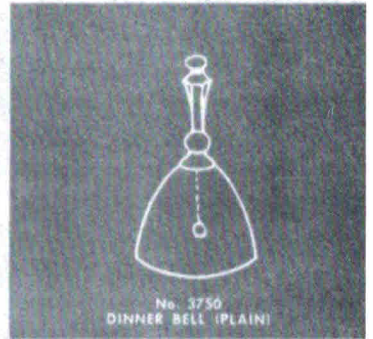

No. 3750
DINNER BELL (PLAIN)



No. 3900/18
2-PIECE COCKTAIL ICER

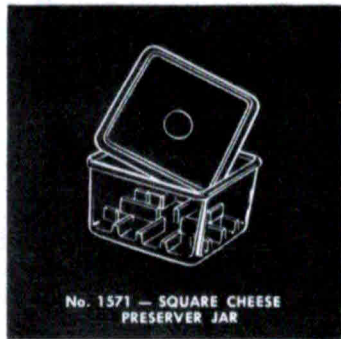

No. 1571 — SQUARE CHEESE
PRESERVER JAR



NO. 3750 — DINNER BELL

NO. 3750 — DINNER BELL



CORINTH 5" COMPORT



No. P-101
32 OZ. COCKTAIL SHAKER



3400/54 — CUP & SAUCER

Gifts



No. V-134 — CAKE SALVER
FLORAL CENTERPIECE



No. 968 — 2-PC. COCKTAIL ICER



No. 3011/3 — SHERBET



No. 3400/91
8" 3-PART RELISH

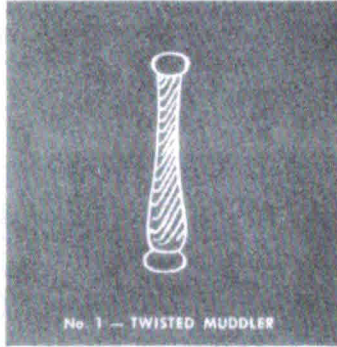

No. 1 — TWISTED MUDDLER

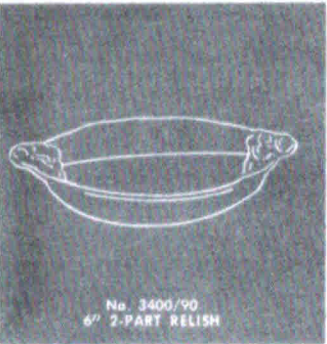

No. 3400/90
6" 2-PART RELISH



No. C-117 — 3 OZ. OIL



No. 445 — MAYONNAISE LADLE



1603—10 in.



No. 7966 — 2 OZ. SHERRY



No. REGENCY — BELL PLAIN



THE CAMBRIDGE GLASS COMPANY, CAMBRIDGE, OHIO, U. S. A.

Gifts



No. P-147
MARMALADE AND COVER

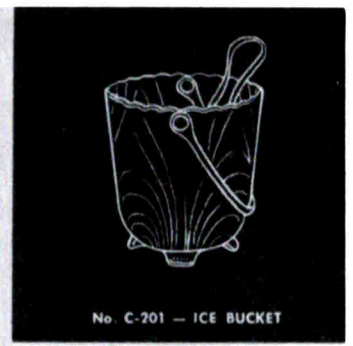

No. C-201 — ICE BUCKET



No. 3900/671 — ICE BUCKET



No. 3797/68
7" HURRICANE LAMP



No. F-151
MUSTARD AND COVER



No. M-122 — 7 1/2" SALAD PLATE

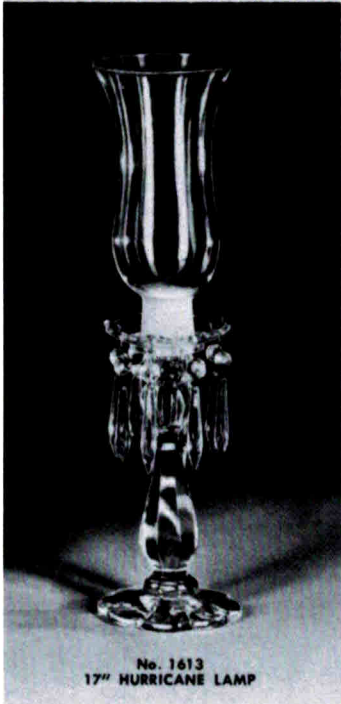

No. 1613
17" HURRICANE LAMP



No. 1617 — HURRICANE LAMP

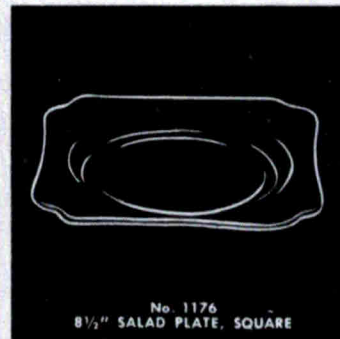

No. 1176
8 1/2" SALAD PLATE, SQUARE

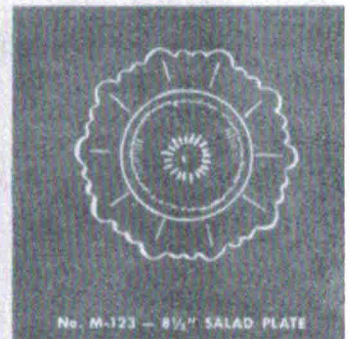

No. M-123 — 8 1/2" SALAD PLATE



No. 3900/118 — 32 OZ. JUG



No. 3900/117 — 30 OZ. JUG



No. 298
MARMALADE AND COVER



No. 1956/2-3-4
FLORAL CENTERPIECE



No. 3900/115 — 76 OZ. JUG



No. 3900/114 — 32 OZ. JUG



THE CAMBRIDGE GLASS COMPANY, CAMBRIDGE, OHIO, U. S. A.



No. C207
CIGARETTE BOX-COVER

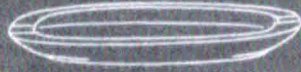

No. P-737 - CANOE ASH TRAY



No. 1956/5 - 8" ASH TRAY



No. P721
2 1/2" SQUARE ASH TRAY



No. 1040 - SWAN ASH TRAY



No. C214/215/216
3-PIECE ASH TRAY SET

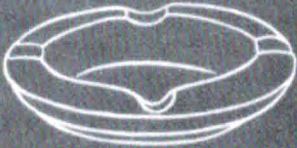

No. 390 - 6" ASH TRAY

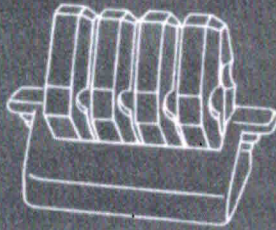

No. P726
5-PIECE ASH TRAY SET



No. 733/4/5 - 3-PIECE ASH TRAY SET



No. 391 - 8" ASH TRAY



No. 1956/2
10" ASH TRAY WITH PEG



No. 3797/152
3-PIECE SMOKER SET



No. P-735 - 6" ASH TRAY

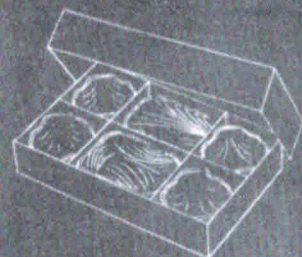

No. C207/213
6-PIECE SMOKER SET



THE CAMBRIDGE GLASS COMPANY, CAMBRIDGE, OHIO, U.S.A.

Smokers' Items



No. P-733 — 3" ASH TRAY



No. P734 — 4½" ASH TRAY

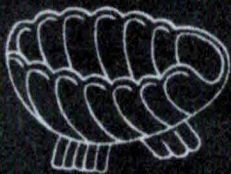

No. C213 — 2½" ASH TRAY WITH CARD HOLDER

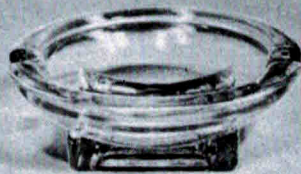

No. 1956/11 — 10" ASH TRAY

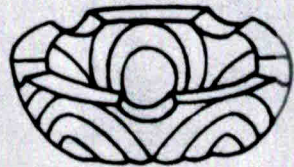

No. C214 — 3" ASH TRAY

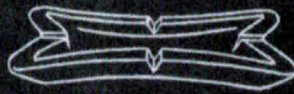

No. 1957/6 — ASH TRAY

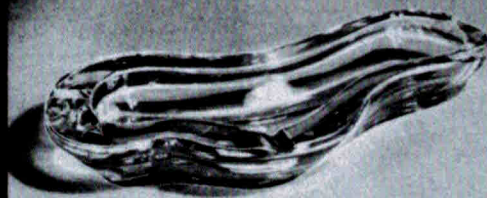

No. 1956/11 — 10" ASH TRAY



No. 3197/11 — 3½" ASH TRAY

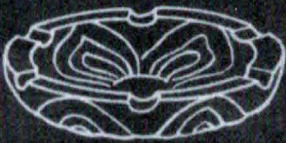

No. C216 — 5" ASH TRAY

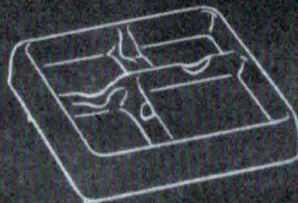

No. 1956/10 — COASTER ASH TRAY AND SPOON HOLDER



No. C215 — 4" ASH TRAY

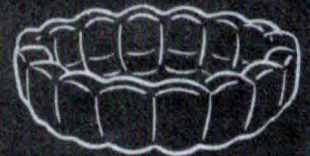

No. 216 — CASCADE 8" ASH TRAY



No. 3400/92
2 1/2 OZ. BALL TUMBLER

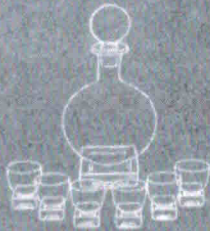

No. 3797/87
7-PIECE CORDIAL SET

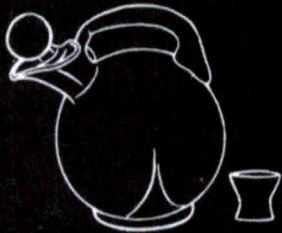

No. 3400/119/1341
7-PIECE CORDIAL SET



No. 3797/85
32 OZ. FOOTED DECANTER



No. 1380 — 26 OZ. SQ. DECANTER
ETCHED OR PLAIN



No. 1541 — 26 OZ. DECANTER
(ETCHED) GIN, BOURBON,
SCOTCH, RYE



No. 1070 — 36 OZ. DECANTER

Decanters



No. 1321/7966
7-PIECE SHERRY SET

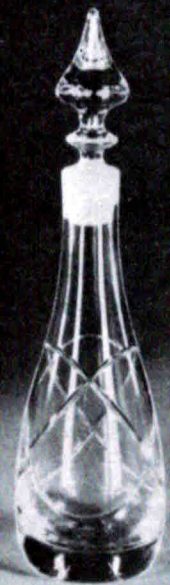

No. 1539 — DECANTER (WEDDING RING)

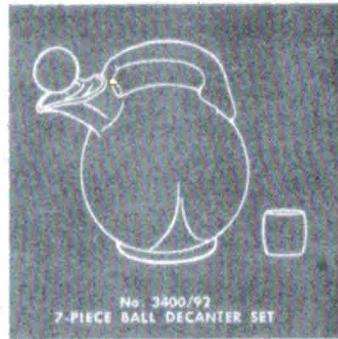
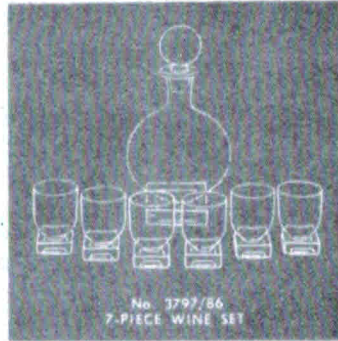
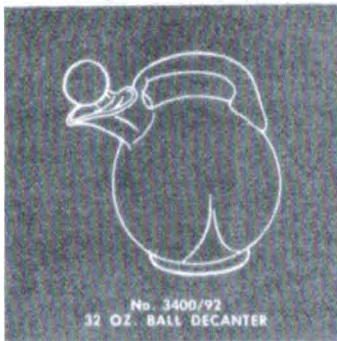
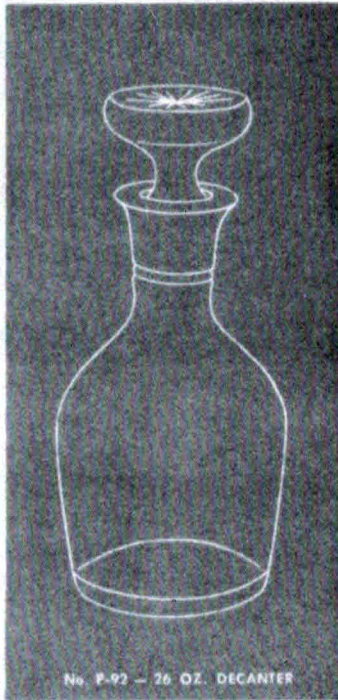
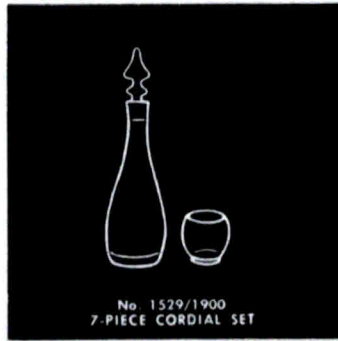
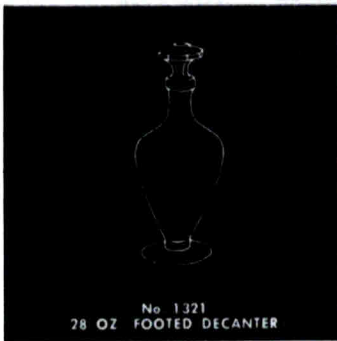
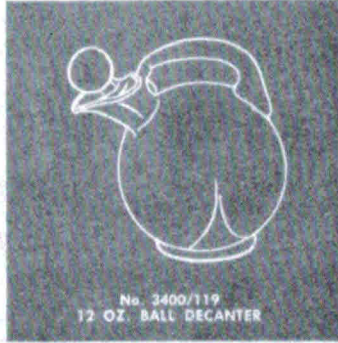
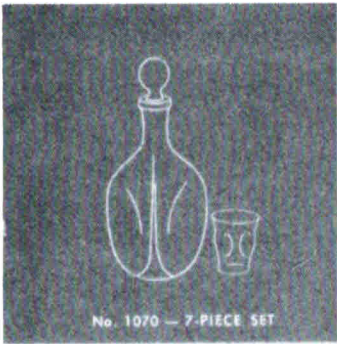

THE CAMBRIDGE GLASS COMPANY, CAMBRIDGE, OHIO, U. S. A.

Punch Sets

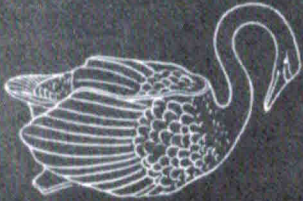

No. 1221 — SWAN BOWL



No. 1221 — SWAN BASE



No. 3200 — BOWL



No. 3200 — BASE



No. 3200 — CUP



No. P-15 — CUP

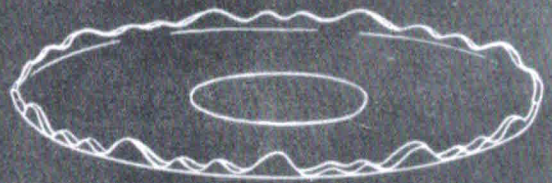

No. M-129 — PLATE



No. P-486 — 5 OZ. CUP



No. 1221 —



No. P-476 — PUNCH BOWL



THE CAMBRIDGE GLASS COMPANY, CAMBRIDGE, OHIO, U.S.A.



No. J.L.-478/488 — 13-PIECE SET



No. 1221 — 5 OZ. SWAN CUP

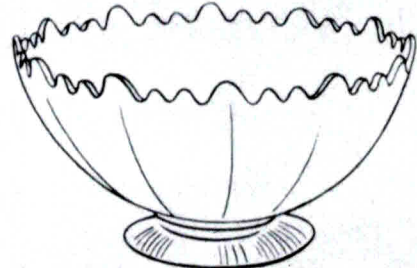

No. M-478 — PUNCH BOWL



No. M-488 — CUP

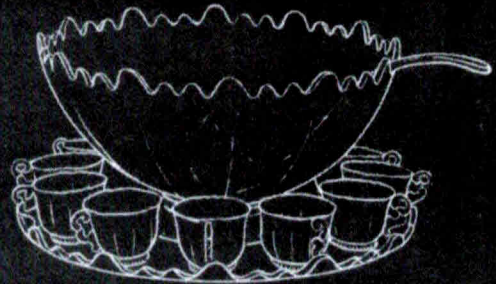

No. M-478/488/129 — 15-PC. SET



No. 3200 — 15-PIECE PUNCH SET

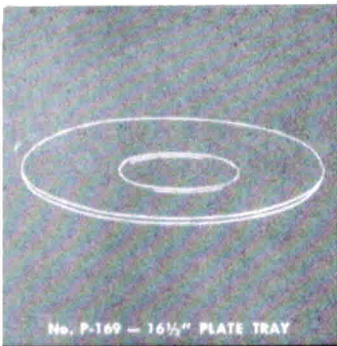

No. P-169 — 16½" PLATE TRAY

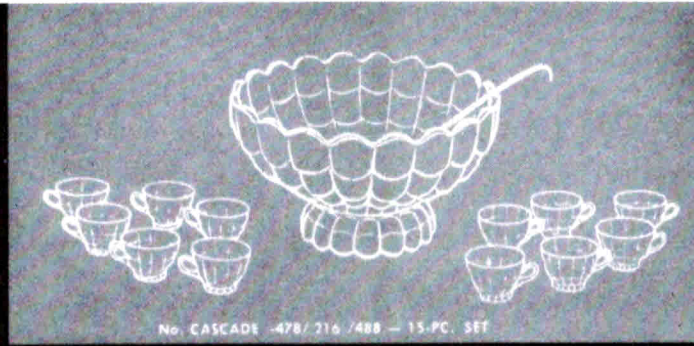

No. CASCADE — 478 / 216 / 488 — 15-PC. SET

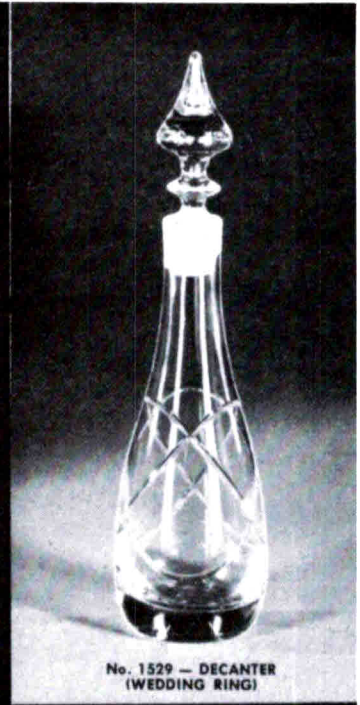

No. 1529 — DECANTER
(WEDDING RING)



No. 3797/476
11½" PUNCH BOWL



No. 3797/13/476
13-PIECE PUNCH SET

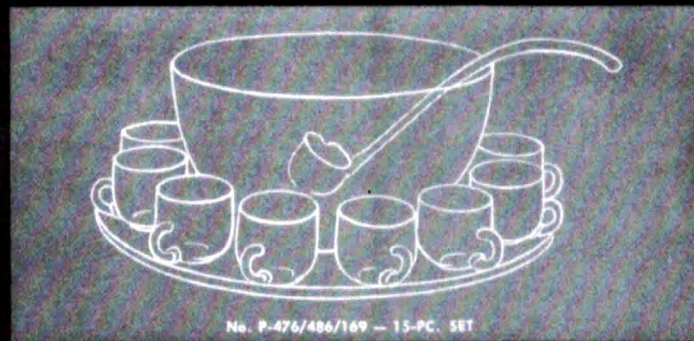

No. P-476/486/169 — 15-PC. SET

Punch Sets

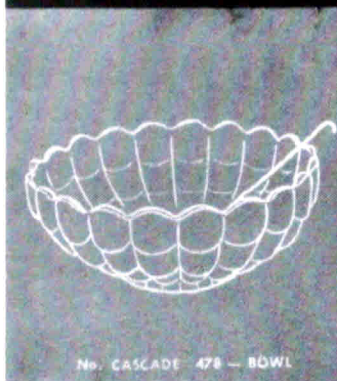

No. CASCADE 478 — BOWL

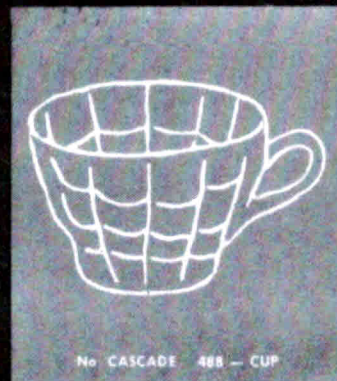

No. CASCADE 488 — CUP

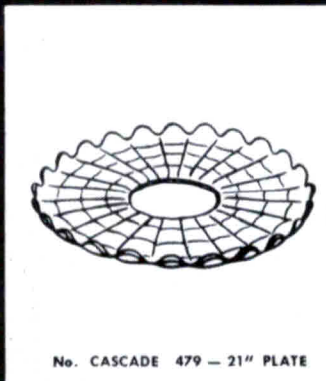

No. CASCADE 479 — 21" PLATE

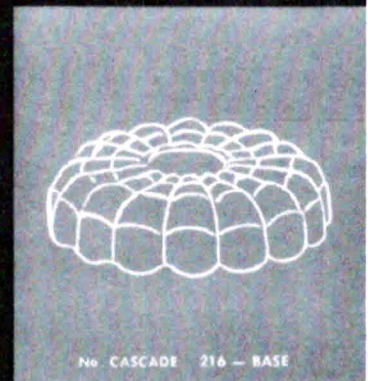

No. CASCADE 216 — BASE

Swans



No. 1040 — 3" SWAN



No. 1401 — 4 1/2" SWAN



No. 1042 — 6 1/2" SWAN



No. 1043 — 8 1/2" SWAN



No. 1044 — 10" SWAN

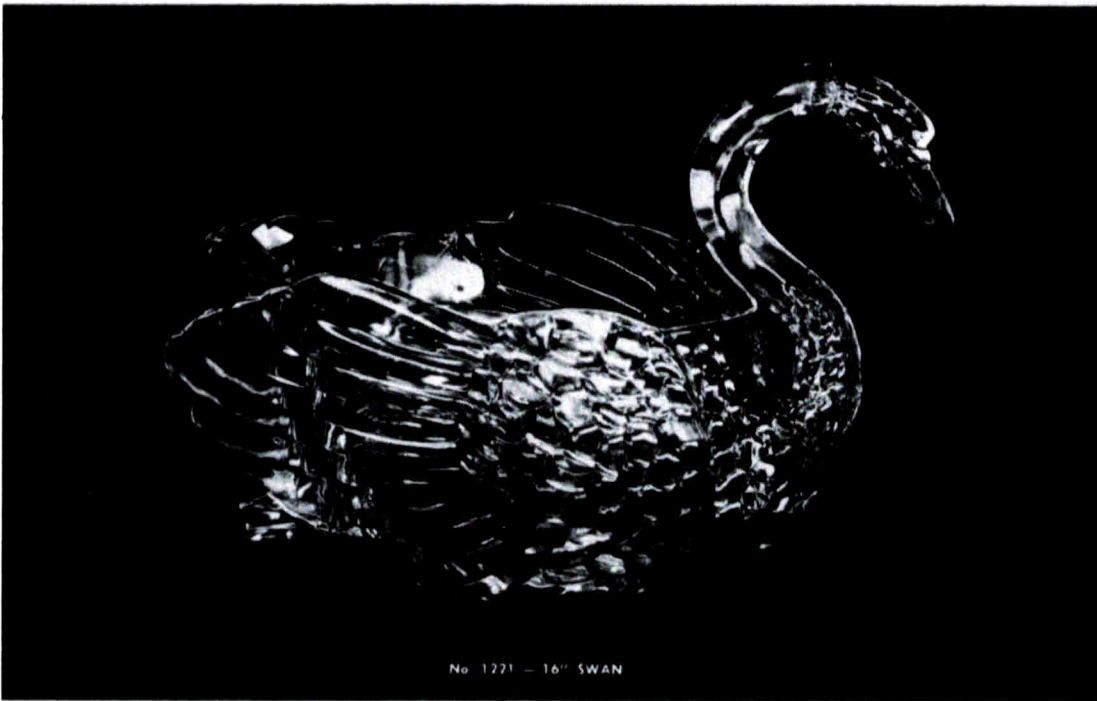

No. 1271 — 16" SWAN



THE CAMBRIDGE GLASS COMPANY, CAMBRIDGE, OHIO, U. S. A.

Epergnes

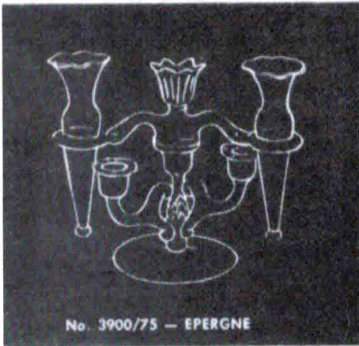

THE CAMBRIDGE GLASS COMPANY, CAMBRIDGE, OHIO, U. S. A.

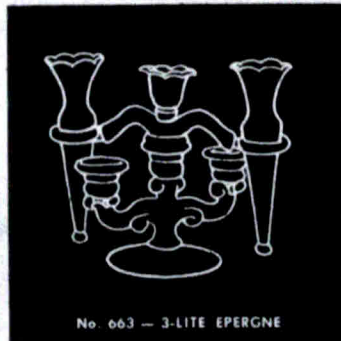
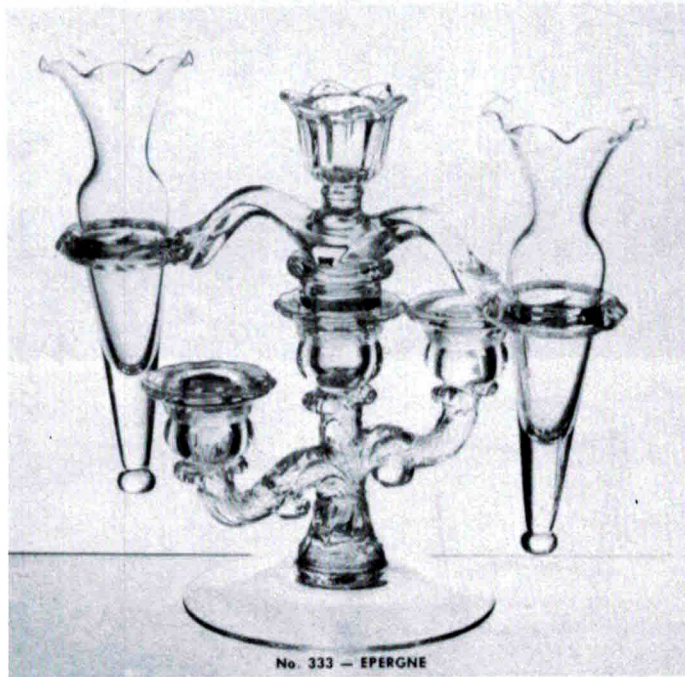
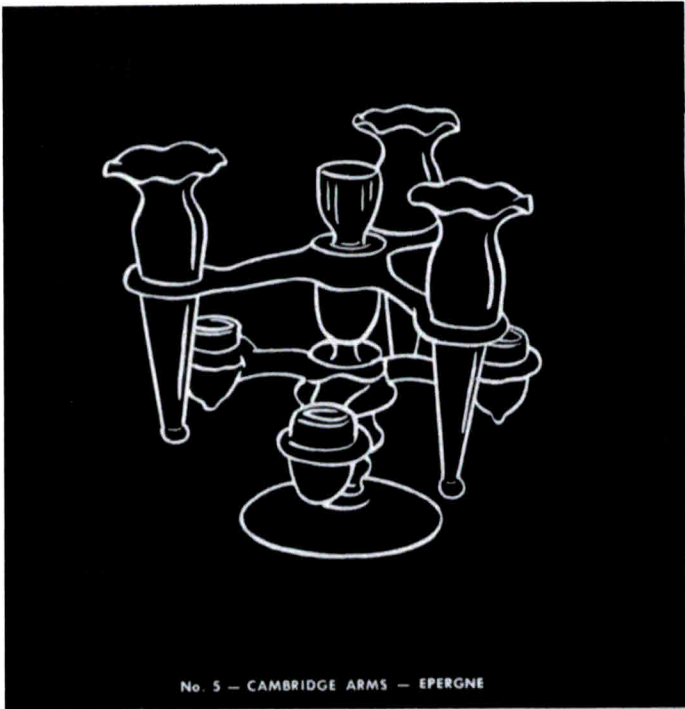



No. 1902 - 1 OZ. TUMBLER

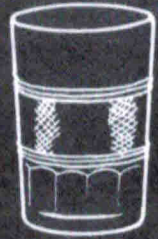

No. M.V.-51
10 OZ. TABLE TUMBLER

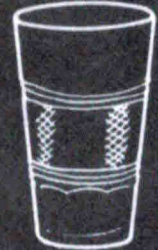

No. M.V.-56
5 OZ. TUMBLER



No. M.V.-58
10 OZ. TALL TUMBLER

Tumblers



No. 496 - 12 OZ. TALL JOE



No. 321 - 7 OZ. O. F. COCKTAIL



No. 321 - 9 OZ. O. F. COCKTAIL



No. C-310
12 OZ. TUMBLER



No. 3900/117 - 5 OZ. TUMBLER



No. 321 - 12 OZ. O. F. COCKTAIL



No. 496 - 1 OZ. LITTLE JOE

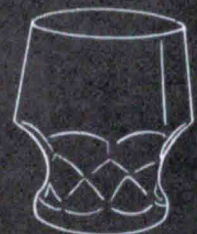

No. 319 - 9 OZ. TUMBLER



THE CAMBRIDGE GLASS COMPANY, CAMBRIDGE, OHIO, U.S.A.



No. M.V.-55
2 OZ. TUMBLER



No. C-310
10 OZ. TABLE TUMBLER

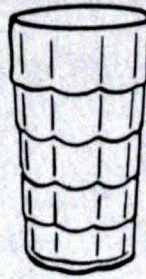

No. CASCADE 14 — 12 OZ. TUMBLER



No. M.V.-57 — 7 OZ. O. F. COCKTAIL



No. 1901 — 2 OZ. WINE

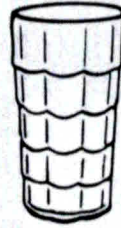

No. CASCADE 15 — 5 OZ. TUMBLER



No. M.V.-59
14 OZ. TUMBLER



No. 321 — 1 1/2 OZ. TUMBLER

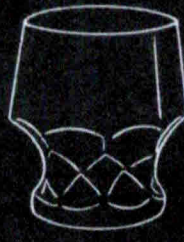

No. 317 — 5 OZ. TUMBLER



No. 497 — 16 OZ. RANCH TUMBLER

No. 1955 — 14 OZ. TUMBLER



No. 1955 — 10 OZ. TUMBLER



No. 1955 — 6 OZ. TUMBLER



No. 1955 — 3 OZ. TUMBLER



No. 1955 — 1 1/2 OZ. TUMBLER



No. 319 — 12 OZ. TUMBLER



No. 1900 — 1 OZ. CORDIAL



No. 497
10 OZ. TUMBLER, SHAM



No. 498 — 5 OZ. TUMBLER



No. 497 — 16 OZ. RANCH TUMBLER



No. 1070 — 2 OZ. PINCHED



No. 1341 — 1 OZ. TUMBLER



No. 497
12 OZ. TUMBLER, SHAM



No. 498 — 10 OZ. TUMBLER



No. 497
14 OZ. TUMBLER, SHAM



No. 3900/115 — 13 OZ. TUMBLER



No. 319 — 9 OZ. TUMBLER



No. 498 — 14 OZ. TUMBLER



No. 498 — 12 OZ. TUMBLER

Tumblers



THE CAMBRIDGE GLASS COMPANY, CAMBRIDGE, OHIO, U.S.A.

Floral Arrangers

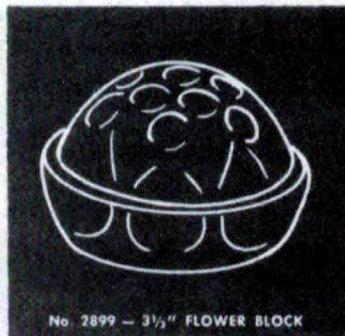

Candlesticks



No. P-493
2 1/4" CANDLESTICK, SQ.



No. P-492
1 3/4" CANDLESTICK, SQUARE

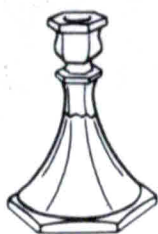

No. 1596 - 6 1/2" CANDLESTICK



No. P-499
6 1/2" CALLA LILY CANDLESTICK



No. 3127 - 7 1/4" T-OUTE



No. 846 - 5" CANDLESTICK



THE CAMBRIDGE GLASS COMPANY, CAMBRIDGE, OHIO, U. S. A.

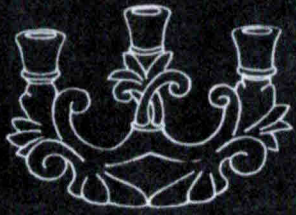

No. 1457 - 6 1/2" 3-LITE CANDLESTICK

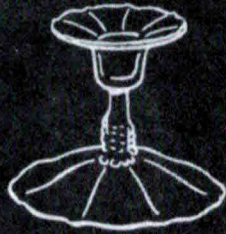

No. 3900/68 - 5" CANDLESTICK



No. 1357 - 6" 3-LITE CANDLESTICK



No. 1307 - 5" 3-LITE CANDLESTICK

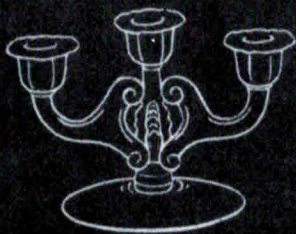

No. 3900/74 - 6" 3-LITE CANDLESTICK

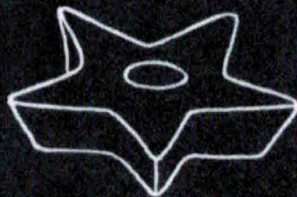

Star No. 1 - 2 1/2" CANDLESTICK

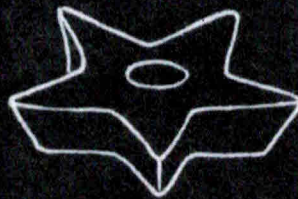

Star No. 2 - 4" CANDLESTICK



No. 647 - 6" 2-LITE CANDLESTICK

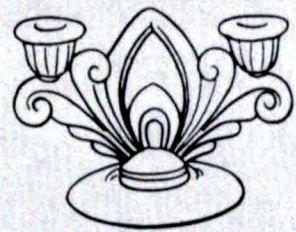

No. 3900/72 - 6" 2-LITE CANDLESTICK

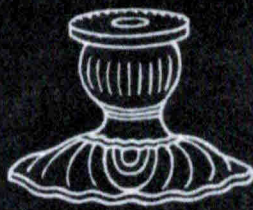

No. C-67 - 2 1/2" CANDLESTICK

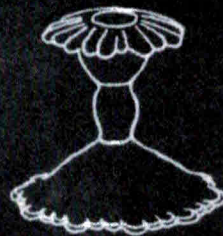

No. 494
MARTHA 4" CANDLESTICK



No. 1338
6" 3-LITE CANDLESTICK

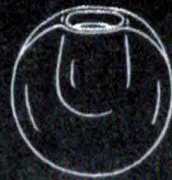

No. P-510
2 1/2" BALL CANDLESTICK

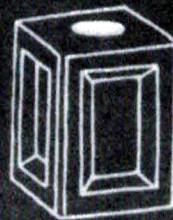

No. P-495
3 1/2" CANDLESTICK, SQUARE

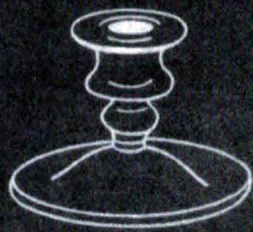

No. 628 - 3 1/2" CANDLESTICK

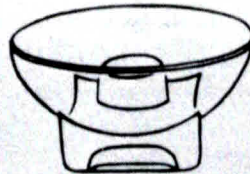

No. 3797/67
CUPPED CANDLESTICK



No. P-506 — 4" 1-LITE



No. 648/19 — 6" 1-LITE



No. 3121 — 7 1/2" 1-LITE

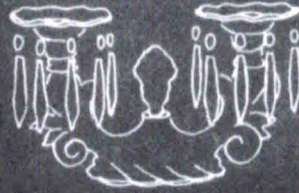

No. 1356 — 7" 2-LITE

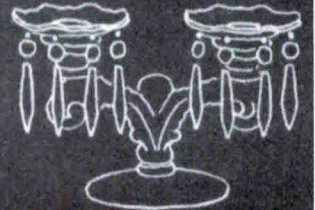

No. M-496 — 6 1/2" 2-LITE

Candelabra

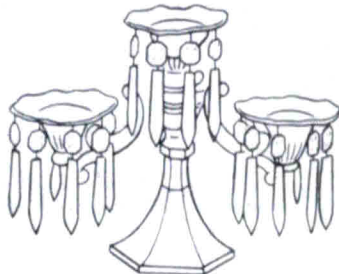

No. 652 — 10" 3-LITE



No. 1440/1 — 9" 1-LITE

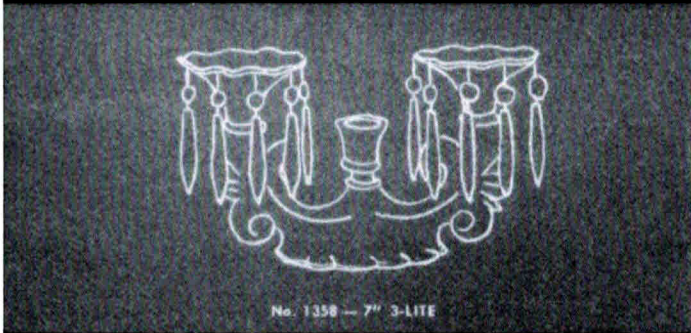
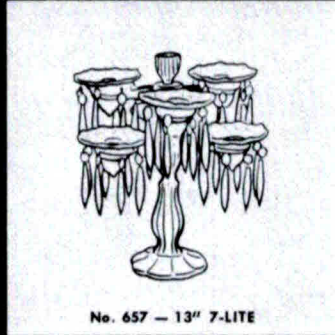
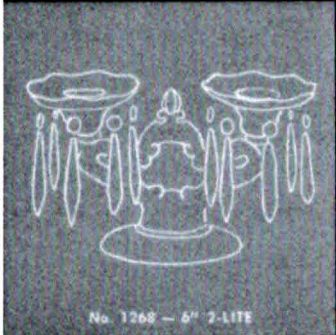
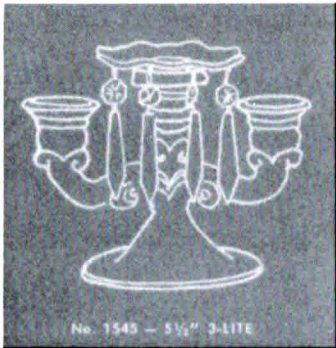

Candelabra



THE CAMBRIDGE GLASS COMPANY, CAMBRIDGE, OHIO, U. S. A.

Cream + Sugars



No. P-253 — INDIVIDUAL
SUGAR AND CREAM



No. C-40
IND. SUGAR AND CREAM



No. M-250 — INDIVIDUAL
SUGAR AND CREAM



No. 1203 — INDIVIDUAL
SALT AND PEPPER

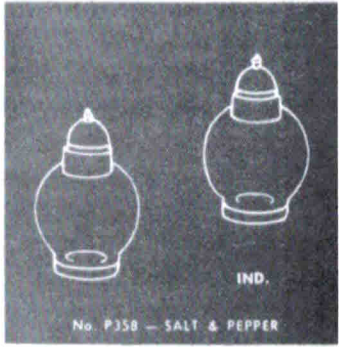

No. P358 — SALT & PEPPER
IND.



No. M.V.-89 — SALT AND PEPPER

No. 1956/105
SALT AND PEPPER

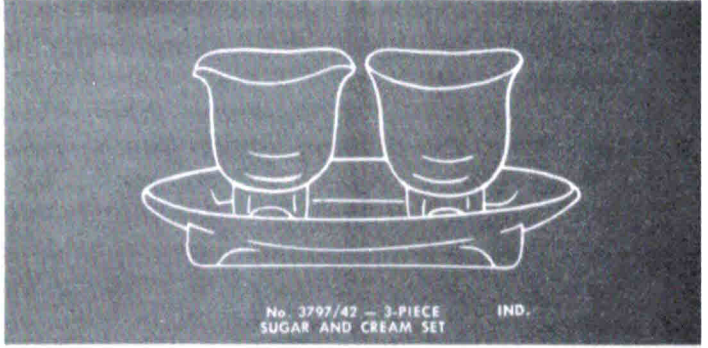

No. 3797/42 — 3-PIECE
SUGAR AND CREAM SET
IND.

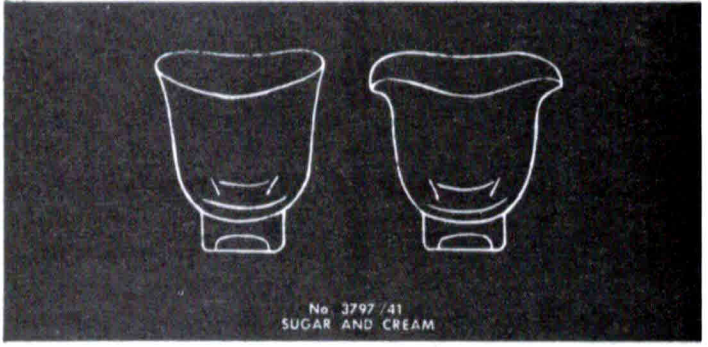

No. 3797/41
SUGAR AND CREAM

Salt + Peppers

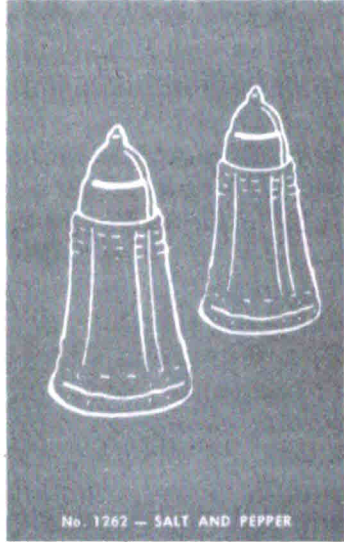

No. 1262 — SALT AND PEPPER

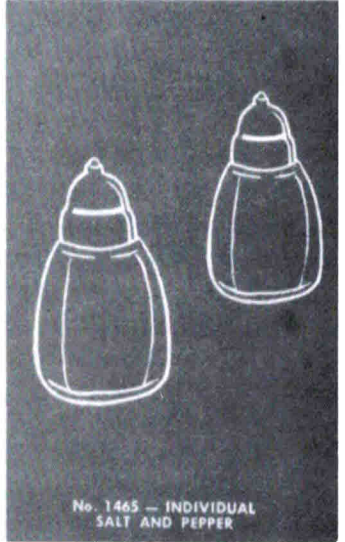

No. 1465 — INDIVIDUAL
SALT AND PEPPER



No. 1476
TALL SALT AND PEPPER

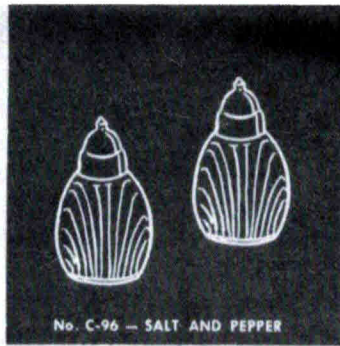

No. C-96 — SALT AND PEPPER

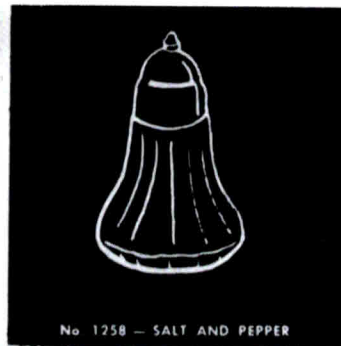

No. 1258 — SALT AND PEPPER



No. 3900/37
SUGAR AND CREAM TRAY

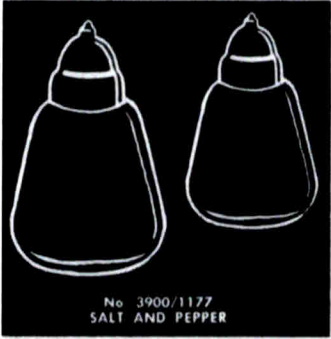

No. 3900/1177
SALT AND PEPPER

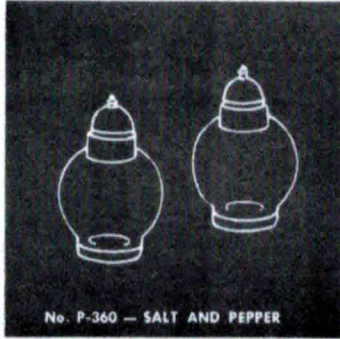

No. P-360 — SALT AND PEPPER

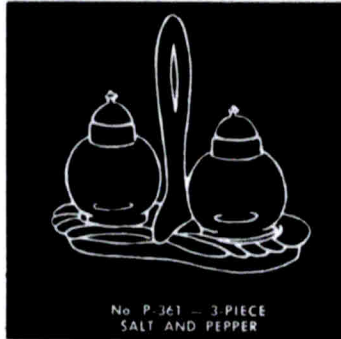

No. P-361 — 3-PIECE
SALT AND PEPPER

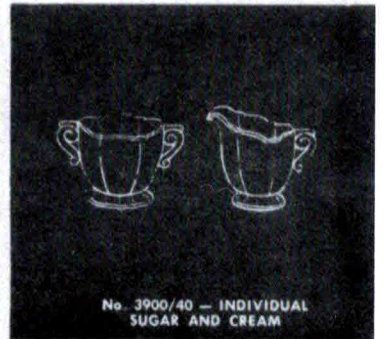

No. 3900/40 — INDIVIDUAL
SUGAR AND CREAM

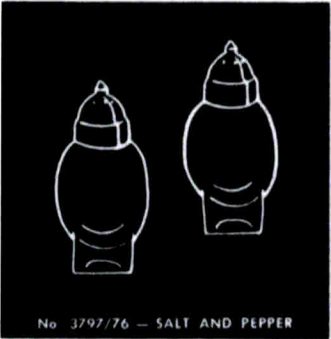

No. 3797/76 — SALT AND PEPPER

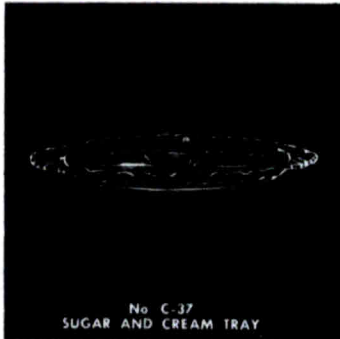

No. C-37
SUGAR AND CREAM TRAY



No. 1957/112 — SALT & PEPPER



No. 3900/38 — 3-PIECE
SUGAR AND CREAM SET

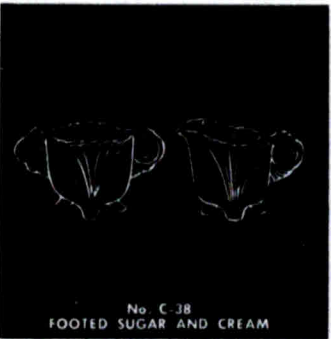

No. C-38
FOOTED SUGAR AND CREAM



No. 3500/15 — INDIVIDUAL
SUGAR AND CREAM

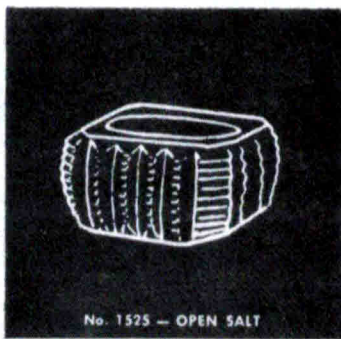

No. 1525 — OPEN SALT



No. 3900/39 — 3-PIECE
SUGAR AND CREAM SET

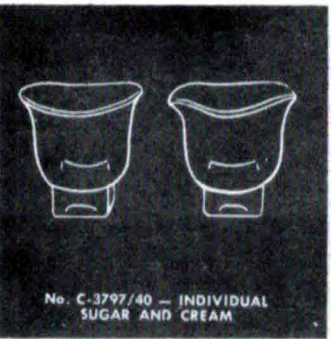

No. C-3797/40 — INDIVIDUAL
SUGAR AND CREAM



No. C-39 — 3-PIECE
SUGAR AND CREAM SET

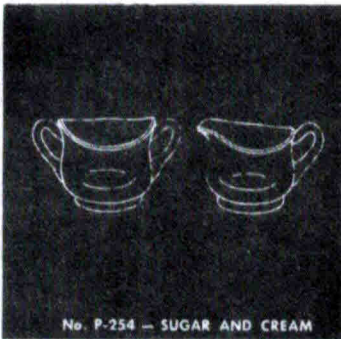

No. P-254 — SUGAR AND CREAM



No. 3900/41
SUGAR AND CREAM



THE CAMBRIDGE GLASS COMPANY, CAMBRIDGE, OHIO, U. S. A.

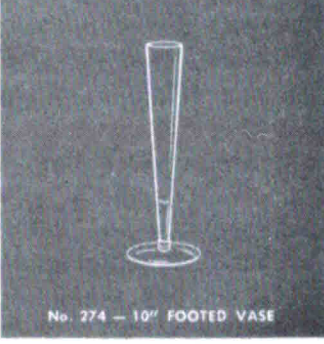
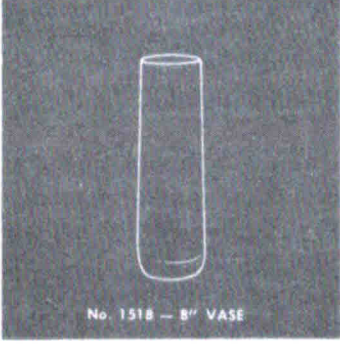
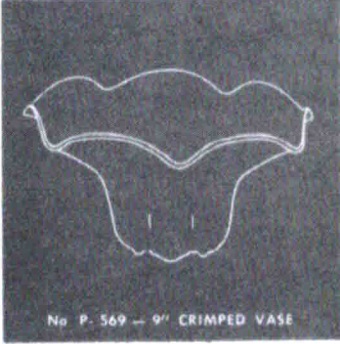
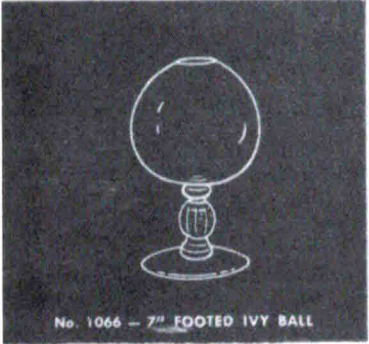
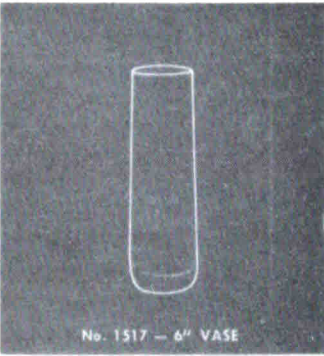
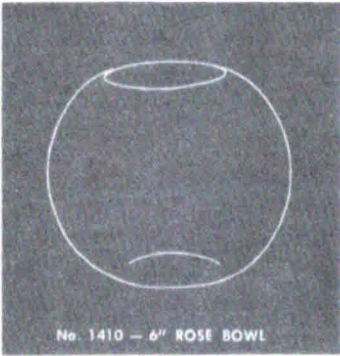

Vases



THE CAMBRIDGE GLASS COMPANY, CAMBRIDGE, OHIO, U. S. A.



No. 1238 — 12" FOOTED VASE

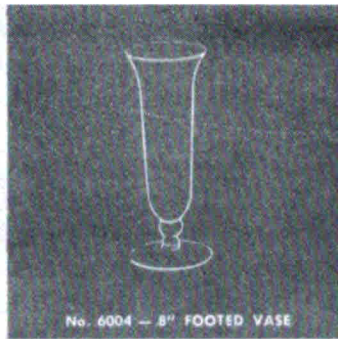

No. 6004 — 8" FOOTED VASE

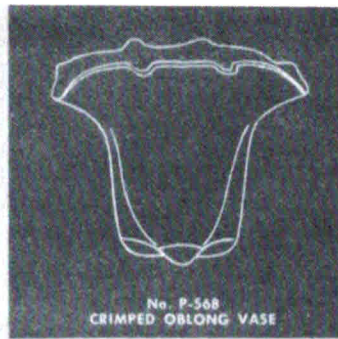

No. P-568
CRIMPED OBLONG VASE

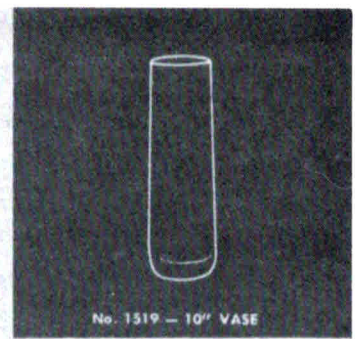

No. 1319 — 10" VASE

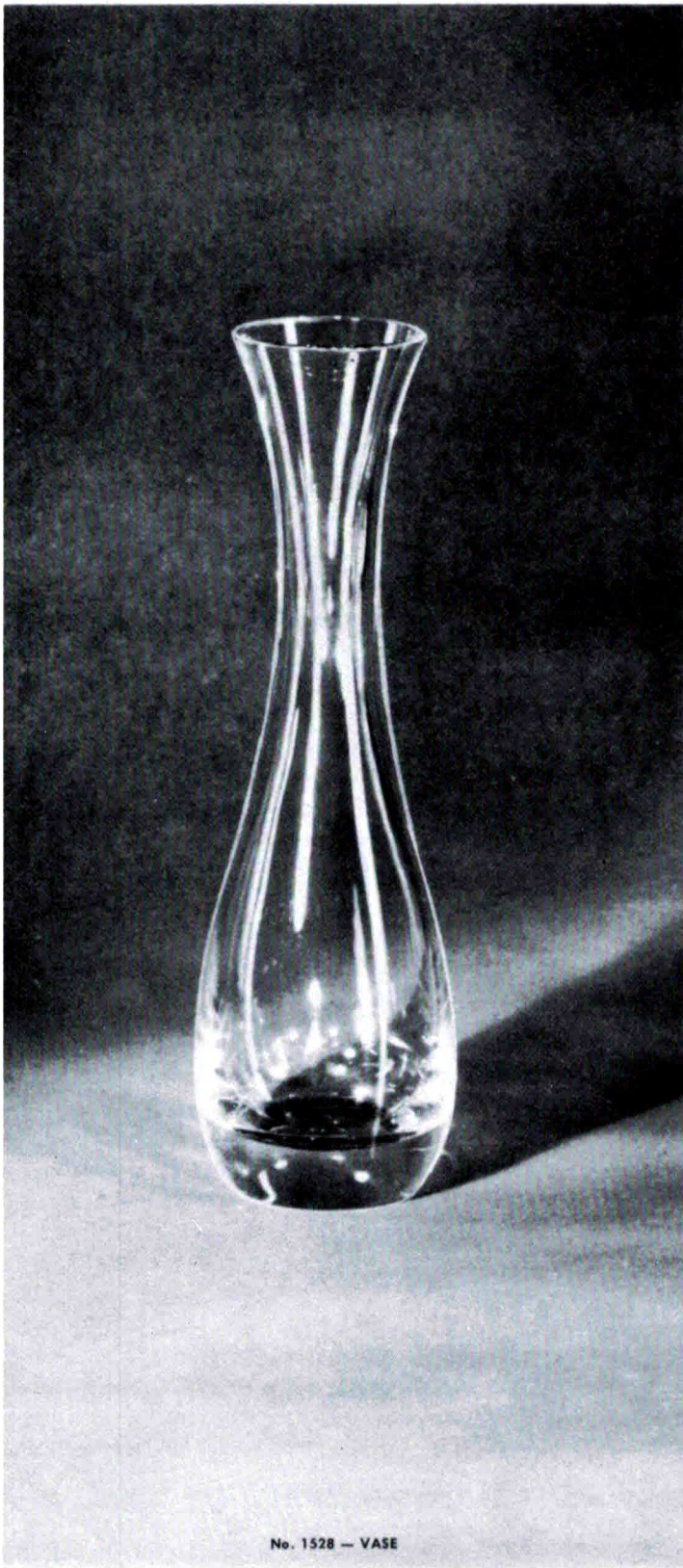

No. 1528 — VASE



No. 3797/77
7 1/2" FOOTED VASE



No. P-563
6" SHARP CRIMPED VASE

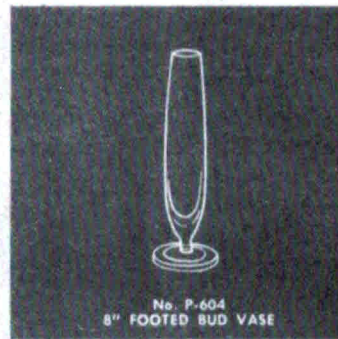

No. P-604
8" FOOTED BUD VASE



No. P-565 — CRIMPED VASE



No. 3797/78
9 1/2" FOOTED VASE



No. 3797 79
11" FOOTED VASE

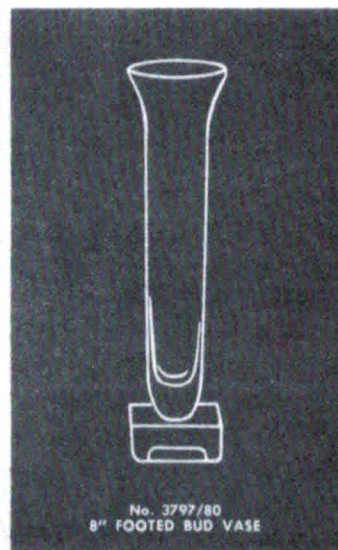

No. 3797/80
8" FOOTED BUD VASE

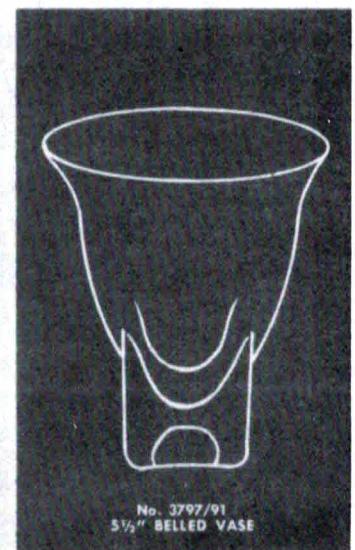

No. 3797/91
5 1/2" BELLED VASE



THE CAMBRIDGE GLASS COMPANY, CAMBRIDGE, OHIO, U. S. A.

Cambridge handmade crystal has long been the final touch of elegance to the loveliest table settings. Its gracious beauty, born of the finest materials, skillfully transformed by proud craftsmen, places Cambridge crystal among the home's most honored possessions. Highly prized among Cambridge coveted crystal creations are the distinctive "Cambridge" decorative table accessories. These graceful crystal-clear units perform sheer magic in beautifying the table because they are so adaptable to unique and clever arrangements. The "Cambridge Arm" can be used as an effective four-candle holder, or it can be a part of a striking ensemble created with other accessory pieces. With this unusual grouping of glassware, you can fulfill your every wish — from a simple, beautiful centerpiece to the most elaborate table arrangement.

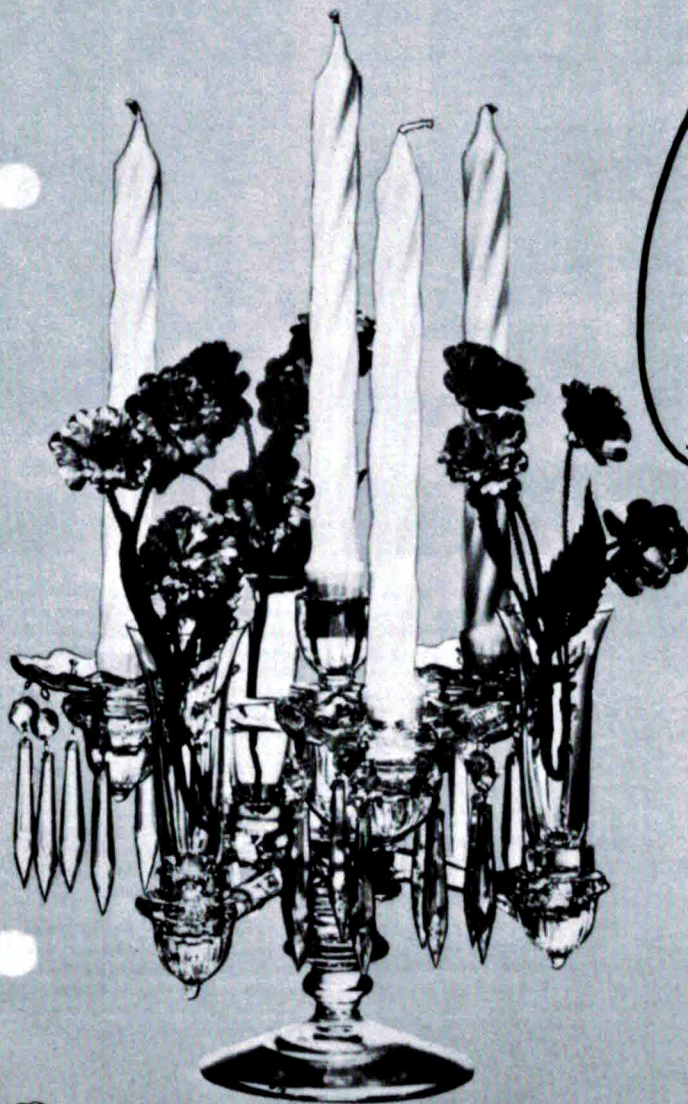

Cambridge Arms



THE CAMBRIDGE GLASS COMPANY, CAMBRIDGE, OHIO, U.S.A.

Cambridge Arms



No. 1596 — 6½" CANDLESTICK

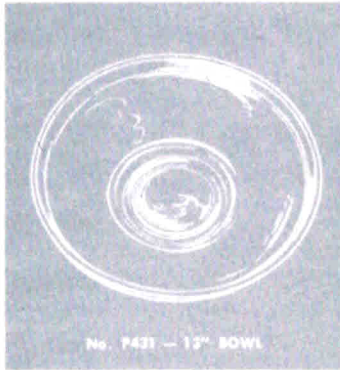

No. P43T — 12" BOWL

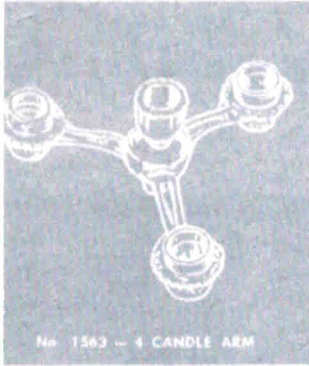

No. 1563 — 4 CANDLE ARM

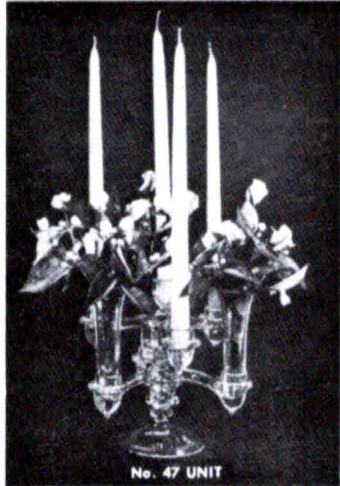

No. 47 UNIT



No. 37 UNIT

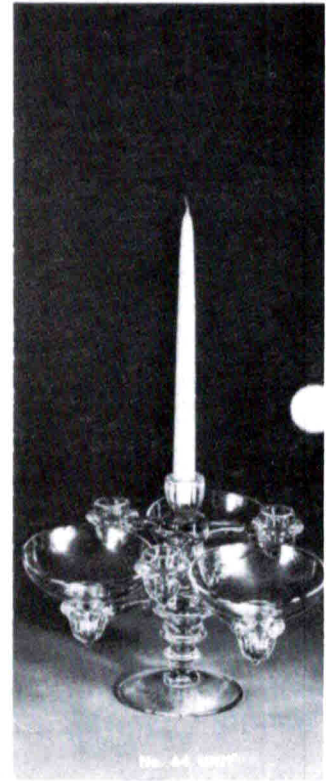

No. 40 UNIT

No. 47 UNIT — This simple but lovely epergne ideal for small settings is created by combining two arms, three peg vases and one low pedestal candlestick. Can be used either low or high. A fine starter unit.

No. 39 UNIT — Tastefully decorated with flowers this unit is a thing of beauty. Consists of one arm with a peg nappy.

No. 43 UNIT — Here is the unique combination of Cambridge pieces which enables you to create scores of different settings . . . a different centerpiece for every meal! Consists of two low pedestals, two "Cambridge Arms", four peg nappies, three peg vases.

No. 40 UNIT — This beautiful creation forms a striking centerpiece for any dinner party. A peg vase is used in the center with two low arms, four peg nappies, one peg vase, put into a low pedestal candlestick arranged as illustrated.

No. 37 UNIT — You can create this lacy looking centerpiece by placing the arm on the low pedestal base with a peg vase in the center well. Consists of one "Cambridge Arm", one low pedestal, one peg vase.

No. 5 EPERGNE — A spectacular arrangement of glassware and flowers. Created by placing the vase arm and "Cambridge Arm" on top of one another in the low pedestal and adding three peg vases.



THE CAMBRIDGE GLASS COMPANY, CAMBRIDGE, OHIO, U. S. A.



No. 628 — LOW CANDLESTICK

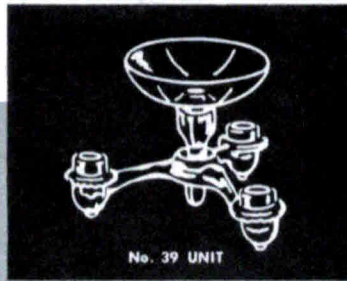

No. 39 UNIT

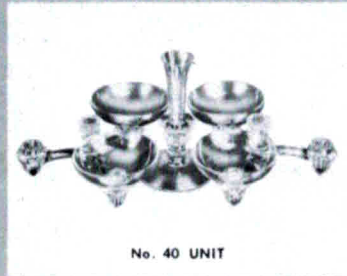

No. 40 UNIT

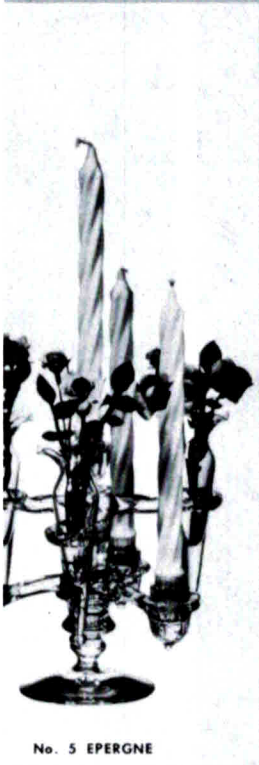

No. 5 EPERGNE



No. 64 UNIT — A beautiful setting suitable for candy, nuts, or low flowers. Can be used for either low or tall centerpiece. Also beautiful with candles and flowers. At the base is the low pedestal. The two "Cambridge Arms" are set in place, with the peg nappies fitting into arms, creating space for flowers.

No. 1596 6½" CANDLESTICK — Truly enhancing the beauty of table or buffet decorations is the graceful Cambridge tall pedestal candlestick. Its beautiful design will help create many striking combinations with other accessories.

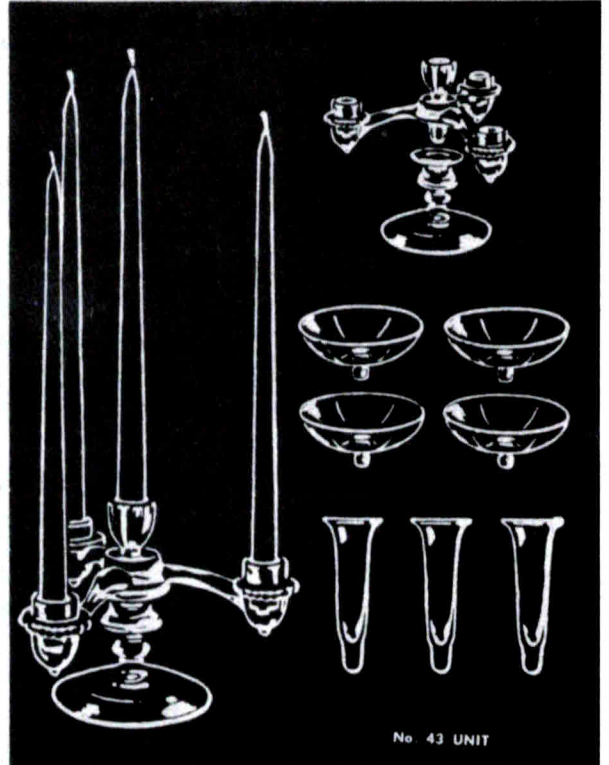

No. 43 UNIT

No. 628 CANDLESTICK — The Cambridge low candlestick is the adaptable base upon which many exciting low spreading centerpieces can be built, or with the arms set on top, rises to distinctive beauty in the center of the table.

No. 431 13" BOWL — The "Cambridge Arm" can be effectively used when placed in the beautiful shallow Cambridge P431 bowl.

No. 1563 4 CANDLE ARM — Fruits or vegetables for the harvest season, holly, spruce, pine and mistletoe for Christmas, lillies for Easter . . . all make wonderful centerpieces by using the "Cambridge Arm" in the shallow bowl, or the "Arm" can be used alone as a distinctive candle holder. This is the beginning of all "Cambridge Arms" masterpieces.

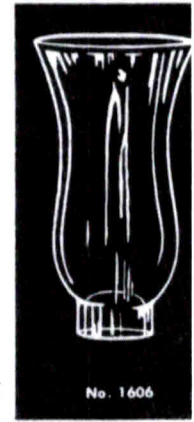
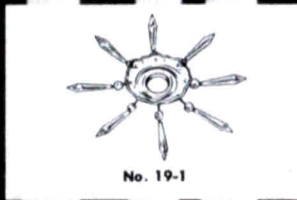
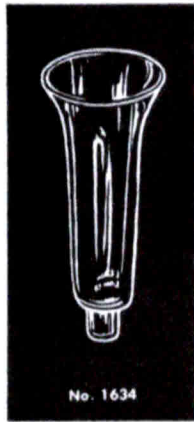
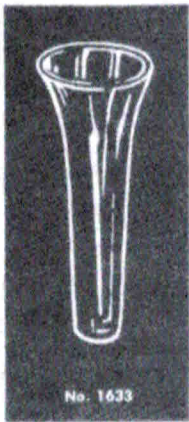

Cambridge Arms

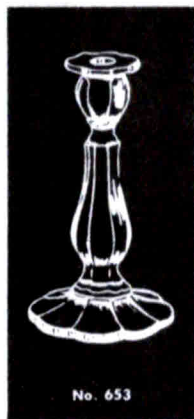

Graceful tall candlesticks, glowing hand-made crystal-clear glass, and lovely flowers make a festive occasion of any dinner. The deluxe units shown in this brochure can be purchased as a complete unit, or you can start with a smaller number of the "Cambridge Arm" units and make up these superb combinations by adding a part from time to time. All this luxury, all this pleasure at a cost far less than you would expect gorgeous glassware to cost!

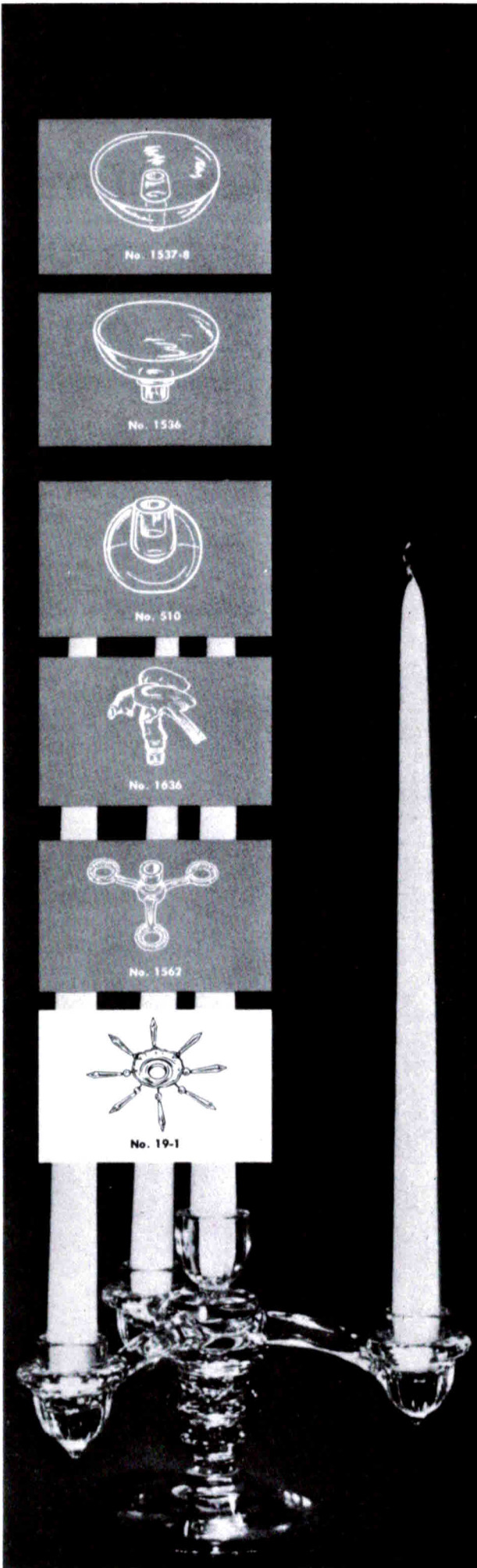



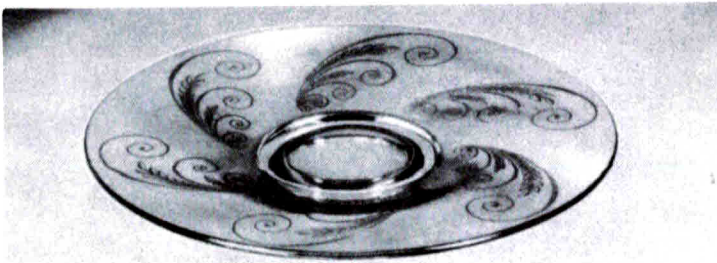

No. P-125 — 14" PLATE



No. 3795
5 OZ. FOOTED TUMBLER



No. 3795 — CORDIAL



No. 3795 — SHERBET



No. 3795
12 OZ. FOOTED TUMBLER

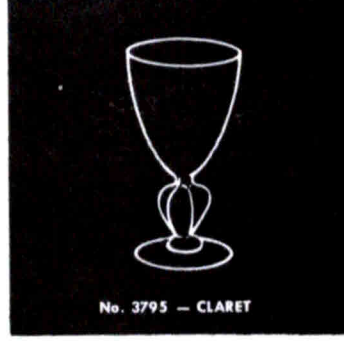

No. 3795 — CLARET

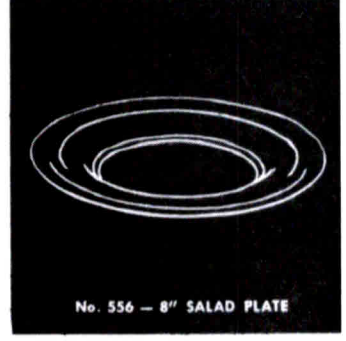

No. 556 — 8" SALAD PLATE



No. 3795 — WINE



No. 3795 — COCKTAIL

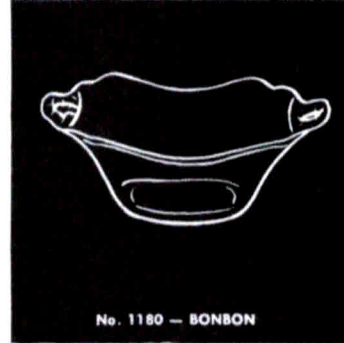

No. 1180 — BONBON



No. 3795 — GOBLET

Paisley



No. 1532
3-PIECE MAYONNAISE SET

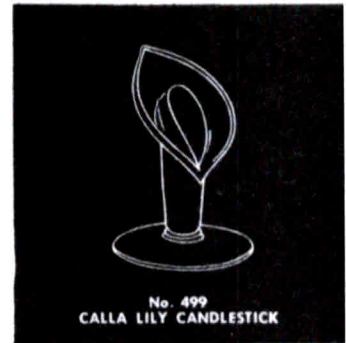

No. 499
CALLA LILY CANDLESTICK



No. 3795 — GOBLET

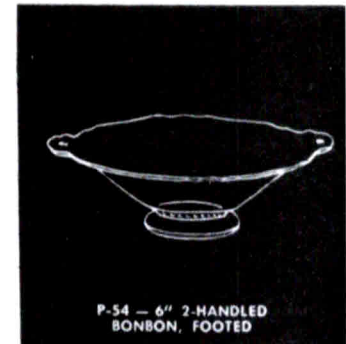

P-54 — 6" 2-HANDLED
BONBON, FOOTED

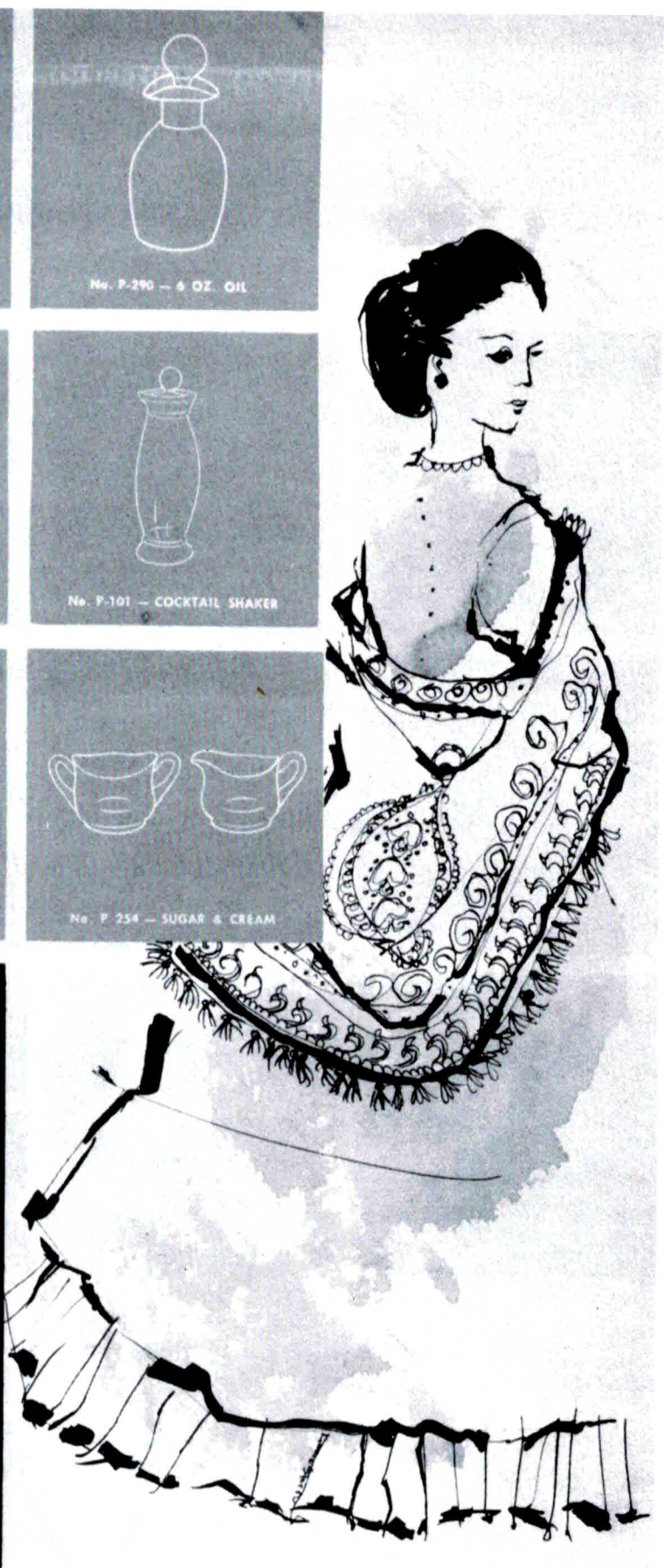
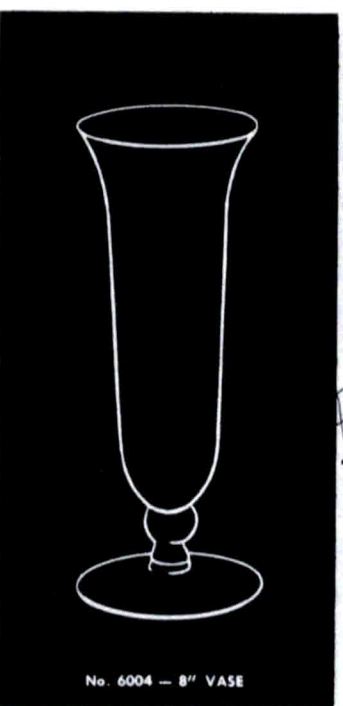
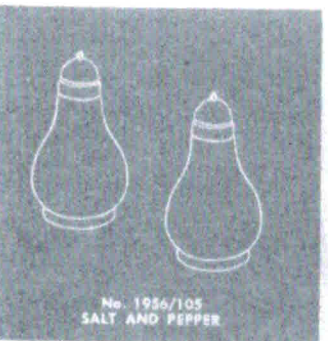
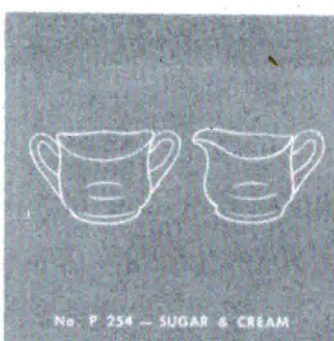
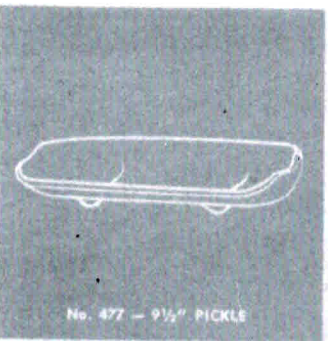
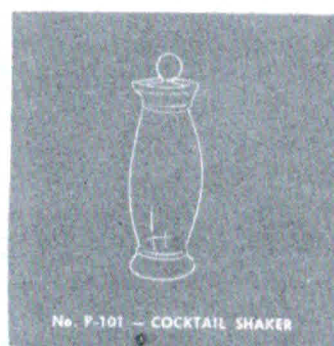
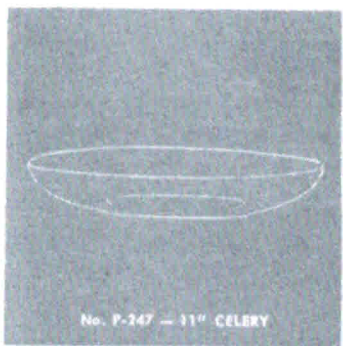
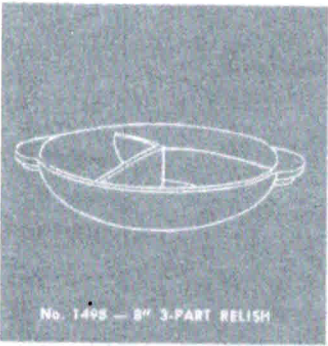
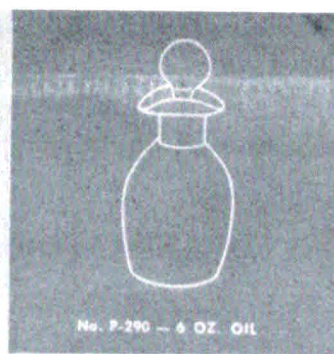
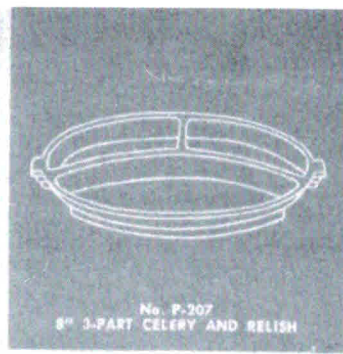
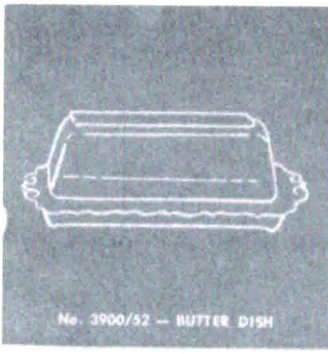

THE CAMBRIDGE GLASS COMPANY, CAMBRIDGE, OHIO, U. S. A.



No. 3600 — 1 OZ. CORDIAL



No. 3600 — 5 OZ. FTD TUMBLER



No. 3600 — 2½ OZ. COCKTAIL

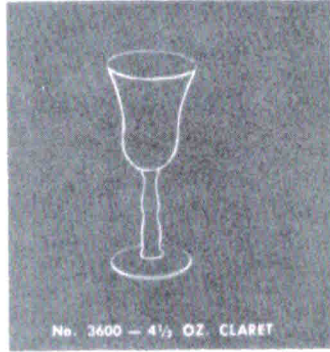

No. 3600 — 4½ OZ. CLARET



No. 3600 — 10 OZ. GOBLET

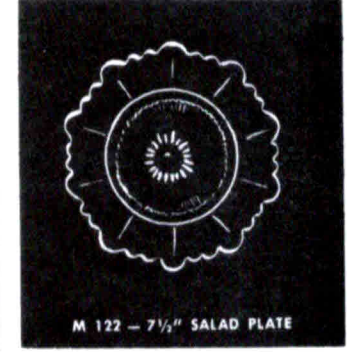

M 122 — 7½" SALAD PLATE

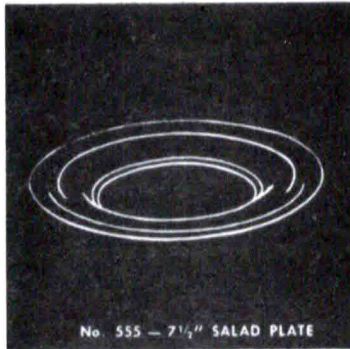

No. 555 — 7½" SALAD PLATE

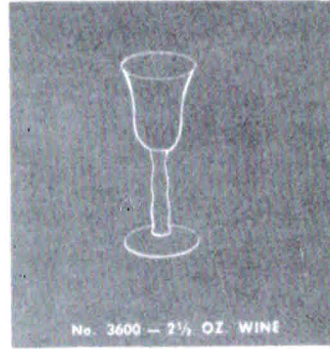

No. 3600 — 2½ OZ. WINE

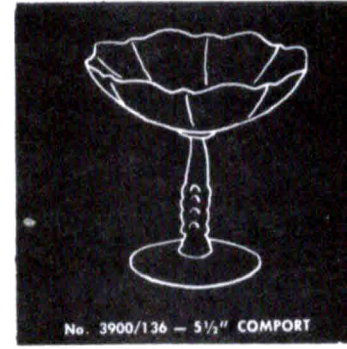

No. 3900/136 — 5½" COMFORT

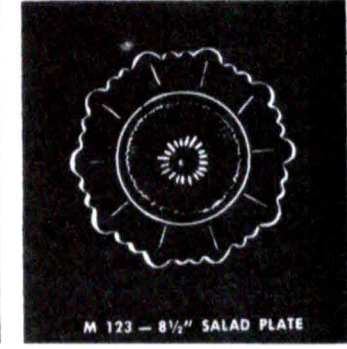

M 123 — 8½" SALAD PLATE



No. 3600
4½ OZ. OYSTER COCKTAIL



No. 3600 — 7 OZ. TALL SHERBET

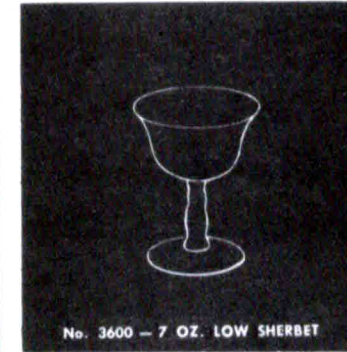

No. 3600 — 7 OZ. LOW SHERBET



No. 3600 — FTD 12 OZ. ICE TEA

Chantilly



THE CAMBRIDGE GLASS COMPANY, CAMBRIDGE, OHIO, U.S.A.

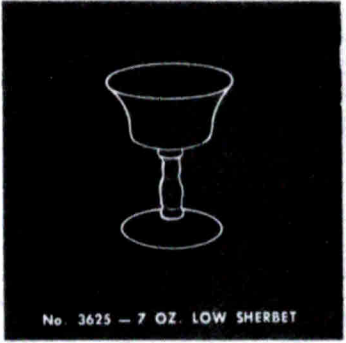
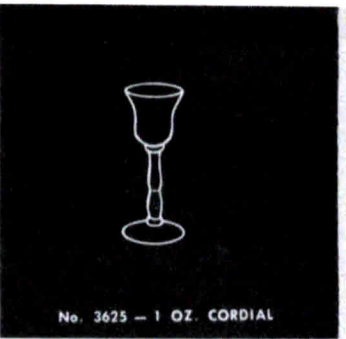



No. 3500/101
3 1/2" TALL COMPOT



No. 3500 - 7 OZ. TALL SHERBET



No. 3500 - 7 OZ. LOW SHERBET



No. 3500 - 3 OZ. COCKTAIL



No. 3500 - 2 1/2 OZ. WINE



No. 3500 - 4 1/2 OZ. CLARET



No. 3500
12 OZ. FOOTED TALL ICE TEA



No. 3500
10 OZ. FOOTED TUMBLER

Rose Point



No. 3121 - 2 1/2 OZ. WINE

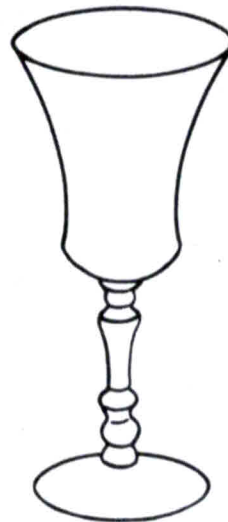

No. 3500 - GOBLET



No. 3500
4 1/2" OYSTER COCKTAIL



No. 3500 - 1 OZ. CORDIAL



No. 3500
5 OZ. FOOTED TUMBLER



No. 3500 - 5 OZ. CAFE PARFAIT



THE CAMBRIDGE GLASS COMPANY, CAMBRIDGE, OHIO, U. S. A.



No. 3121 — 2 1/2 OZ WINE

No. 3121 — GOBLET

ROSE POINT



No. 3900/36 IND.
3 PC. SUGAR & CREAM

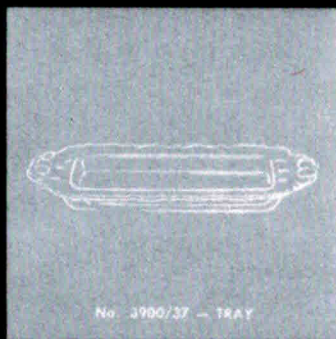

No. 3900/37 — TRAY



No. 3900/40 IND
SUGAR AND CREAM

Chantilly
Rose Point
Wildflower

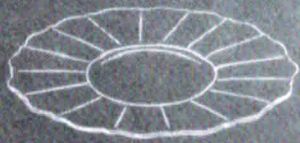

No. 3900/26
12" 3-FOOTED PLATE



No. 3900/19
2-PIECE MAYONNAISE SET

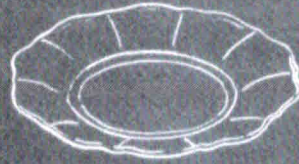

No. 3900/20
6 1/2" BREAD & BUTTER PLATE

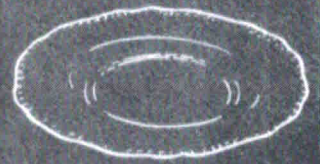

No. 3500/167
7 1/2" SALAD PLATE
No. 3500/5 - 8 1/2" SALAD PLATE

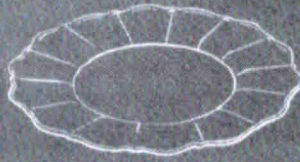

No. 3900/24
10 1/2" DINNER PLATE

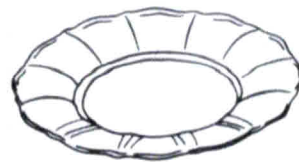

No. 3900/22 - 8" SALAD PLATE

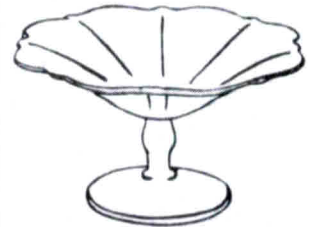

No. 3900/135 - 5" COMPORT



No. 3900/671 - ICE BUCKET,
CHROME HANDLE



No. 3900/135
13 1/2" CHEESE AND CRACKER



No. 1532 - 3 PC. MAY SET



No. 3900/17 - CUP AND SAUCER



No. 968 - 2 PC. COCKTAIL ICER



THE CAMBRIDGE GLASS COMPANY, CAMBRIDGE, OHIO, U. S. A.

Rose Point Chantilly Wildflower



No. 3625 — GOBLET CHANTILLY

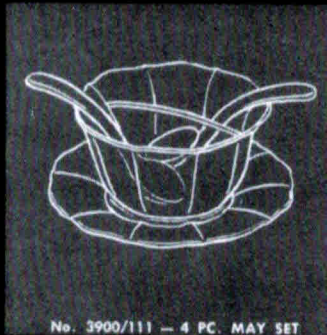

No. 3900/111 — 4 PC. MAY SET

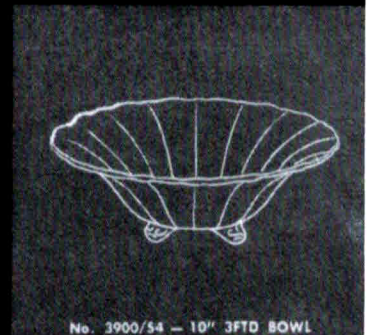

No. 3900/54 — 10" 3FTD BOWL

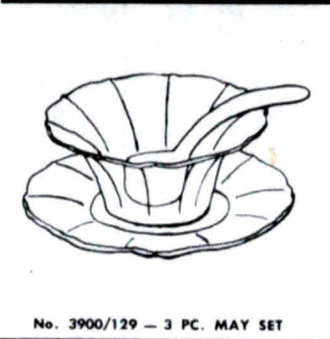

No. 3900/129 — 3 PC. MAY SET



No. 3900/136 — 5 1/2" COMPORT



No. 3900/165
CANDY BOX=COVER



No. 3900/131
8" 2 HANDLE BONBON PLATE



No. 3121 - 12 OZ. FTD. ICE TEA



No. 3121 - 10 OZ. FTD. TUMBLER



No. 3121 - 2 1/2 OZ. WINE

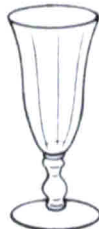

No. 3121
FOOTED 5 OZ. TUMBLER



No. 3121 - 3 OZ. COCKTAIL



No. 3121 - 4 1/2 OZ. CLARET



No. 3121 - GOBLET



No. 3121 - 6 OZ. TALL SHERBET



No. 3121 - 6 OZ. LOW SHERBET

Rose Point & Wildflower



No. 3121 - GOBLET
ROSE POINT



No. 3121 - GOBLET
WILDFLOWER



No. 3121
4 1/2 OZ. OYSTER COCKTAIL



No. 3121 - CAFE PARFAIT



No. 3121 - 1 OZ. CORDIAL



No. 3121 - 2 1/2 OZ. LOW WINE

Chantilly Rose Point Wildflower



No. 3900/52 — 1/4 LB.
BUTTER AND COVER



No. 1232 — 9" VASE



ROSE POINT
No. 3121 — GOBLET

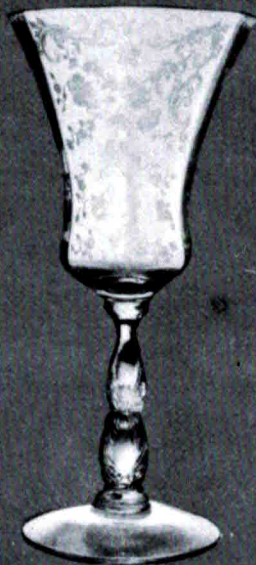

CHANTILLY
No. 3625 — GOBLET



WILDFLOWER
No. 3121 — GOBLET

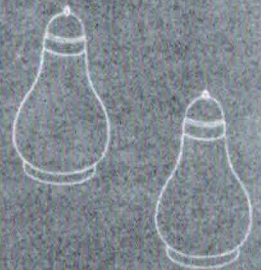

No. 195c/105 — SALT AND PEPPER

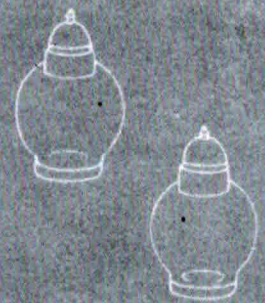

No. P 360 — SALT AND PEPPER



No. 3121 — DINNER BELL



No. 278 — 11" FTD VASE

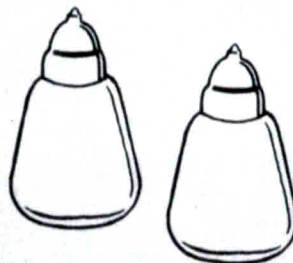

No. 3900/1177
SALT AND PEPPER



No. 3900/39
3 PC. SUGAR & CREAM SET



No. 1321
28 OZ. FOOTED DECANTER



No. 7966 — 2 OZ. SHERRY



No. 3900/114
32 OZ. MARTINI JUG



No. 3121 — 5 1/4" COMPORT



No. 1321/7966
7 PC SHERRY SET

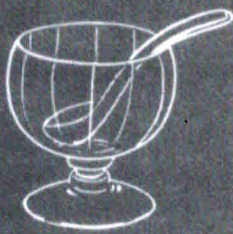

No. 3900/19
2 PC. MAYONNAISE SET

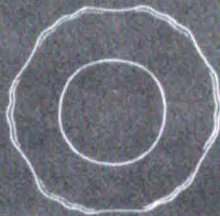

No. 3400/176
7 1/2" SALAD PLATE

Rose Point Wildflower Chantilly

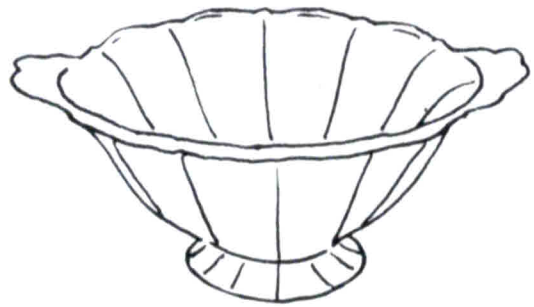

No. 3900/130 — 7" HDL BONBON



No. 3900/41 — SUGAR & CREAM

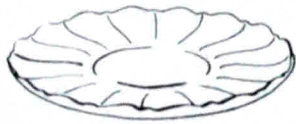

No. 3900/166 — 14" PLATE

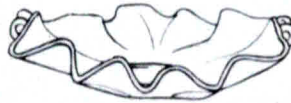

No. 3900/66 — CRIMPED BOWL

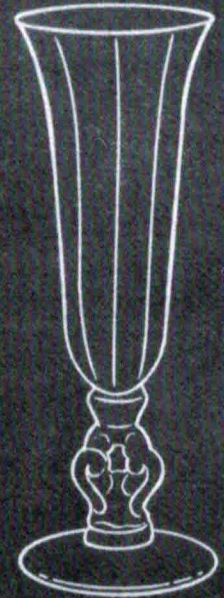

No. 1238 — 12" VASE



No. P101/7801
7-PIECE COCKTAIL SET



No. 6004 — 6" VASE



No. 3900/115 — 76 OZ. JUG



No. 3900/115 — 13 OZ. TUMBLER



No. 7801 — 4 OZ. COCKTAIL

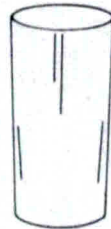

No. 498 — 14 OZ. TUMBLER X



No. 3900/117 — 20 OZ. JUG



No. 6004 — 8" FTD VASE

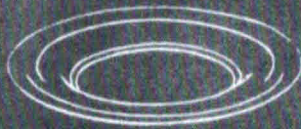

No. 555 — 7 1/2" SALAD PLATE



No. 3900/100 — 6 OZ. OIL

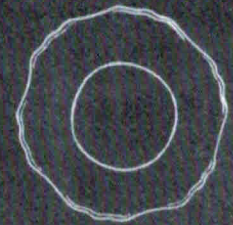

No. 3400/62 — 8 1/2" SALAD PLATE



THE CAMBRIDGE GLASS COMPANY, CAMBRIDGE, OHIO, U. S. A.



No. 3900/117 - 5 OZ. TUMBLER

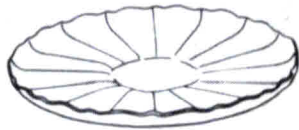

No. 3900/33
13" 3-FOOTED PLATE



No. 646 - 5" CANDLESTICK

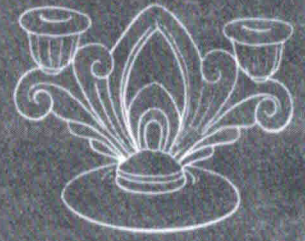

No. 3900/72
6" 2 LITE CANDLESTICK



No. 3900/118 - 32 OZ. JUG



No. 274 - 10" BUD VASE

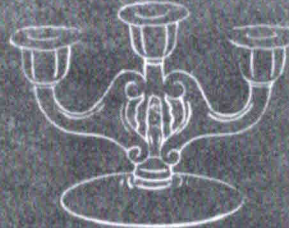

No. 3900/74
6" 3-LITE CANDLESTICK



No. 3900/17 - CUP & SAUCER

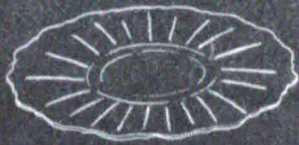

No. 3900/167 - 14" PLATE



No. 477 - 9 1/2" PICKLE

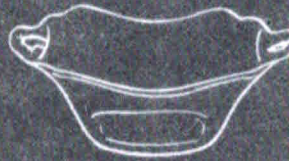

No. 3400/1180
5 1/4" 2 HDL. BONBON

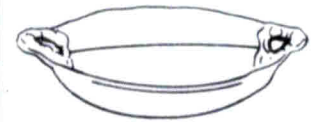

No. 3400/90 - 6" 2-PART RELISH



P56 - 8" 2-HANDLED PLATE



No. 1603 - 10" HURRICANE LAMP

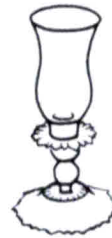

No. 1617 - HURRICANE LAMP

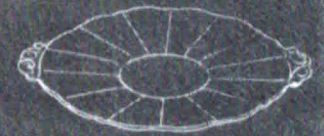

No. 3900/35 - 13 1/2" 2-HANDLED
CAKE PLATE



No. 3900/68 - 5" CANDLESTICK



No. 647 - 6" CANDLESTICK

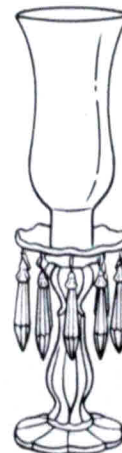

No. 1613 - 17" HURRICANE LAMP



No. 1338
6" 3 LITE CANDLESTICK

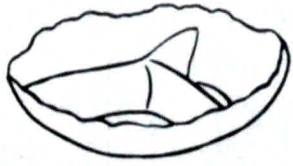

No. 3500/69
6 1/2" 3-PART RELISH



No. 3400/160 — 12" 4 FTD BOWL



No. 3900/126
12" 3 PART CELERY & RELISH

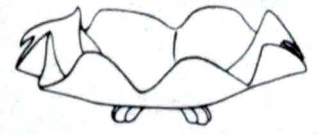

No. 3400/48 — 11" 4 FTD BOWL



No. 3400/91 — 8" 3 PART RELISH

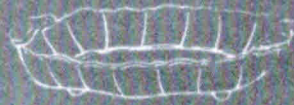

No. 3900/123
7" RELISH AND PICKLE

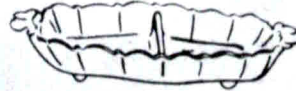

No. 3900/124 — 7" 2 PART RELISH

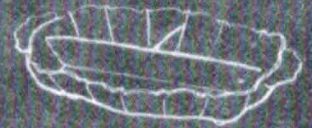

No. 3900/125
9" 3-PART CELERY AND RELISH

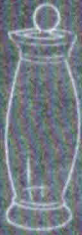

No. P 101
36 OZ. COCKTAIL SHAKER



No. 3400/1181
6" HANDLED PLATE

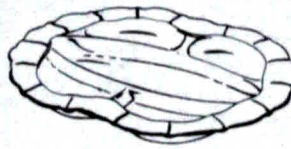

No. 3900/120
12" 5-PART CELERY AND RELISH

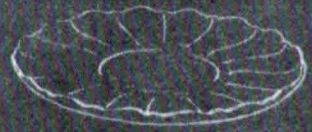

No. 3900/146 — 14" PLATE



No. P 54 — 6" 2 HDL. BONBON

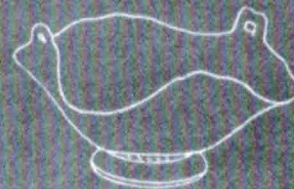

No. P 55 — 6" 2 HDL. BASKET



No. 3500/15 — INDIVIDUAL
SUGAR AND CREAM

Rose Point Wildflower Chantilly



Achilles

No. 698

ROCK CRYSTAL ENGRAVED



No. 3121 - 4 1/2 OZ. CLARET



No. 3121 - 5 OZ. FTD TUMBLER



No. 3121
6 OZ. LOW SHERBET



No. 3121 - COCKTAIL



No. 3121
10 OZ. FOOTED TUMBLER

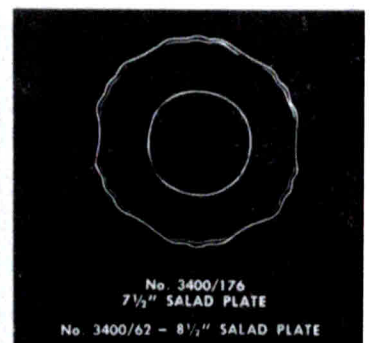

No. 3400/176
7 1/2" SALAD PLATE
No. 3400/62 - 8 1/2" SALAD PLATE



No. 3121 - TALL SHERBET



No. 3121 - 2 1/2 OZ. WINE



No. 968
2-PIECE COCKTAIL ICER



No. 3900/22 - 8" SALAD PLATE



No. 3121 - 10 OZ. GOBLET



No. 3121
12 OZ. FOOTED ICE TEA



No. 3121
4 1/2 OZ. OYSTER COCKTAIL



No. 3121 - 1 OZ. CORDIAL



No. 3121 - COCKTAIL

No. 3121 - TALL SHERBET



No. 3121 - GOBLET

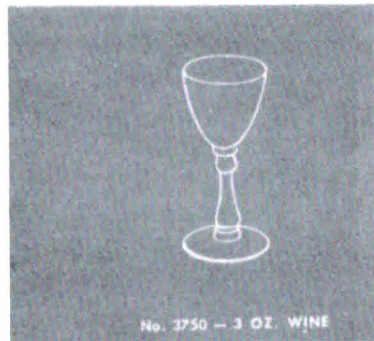
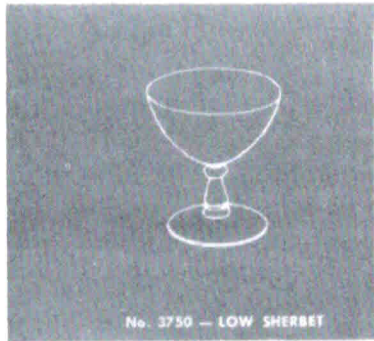

No. 1014
Bexley
ROCK CRYSTAL ENGRAVED

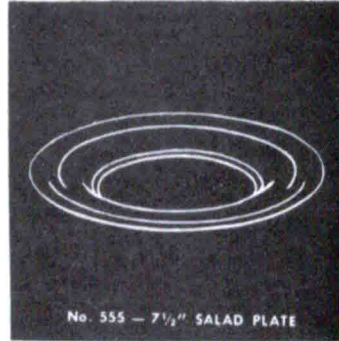
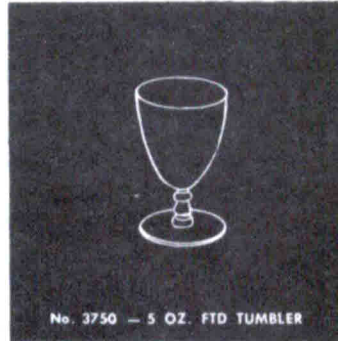
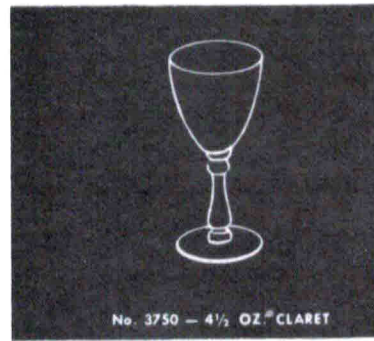

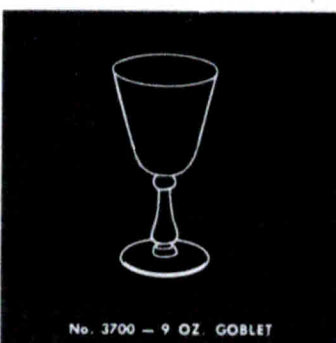
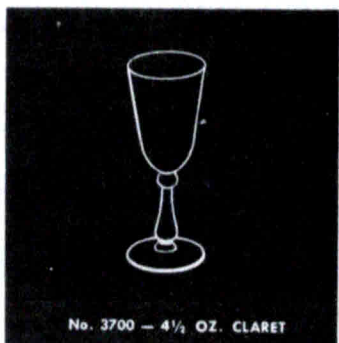
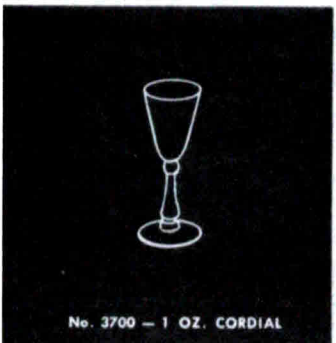
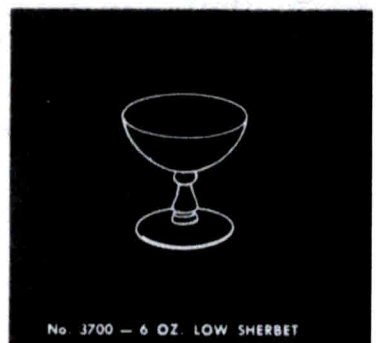
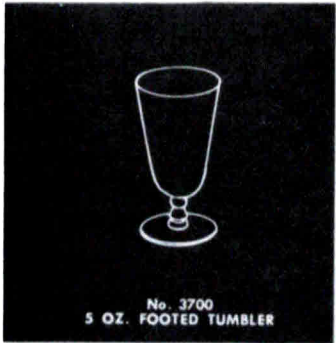
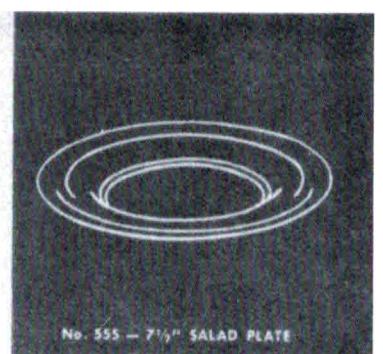

ROCK CRYSTAL ENGRAVED

No. 1005

Ardstley &

Cambridge

No. 1074

Rose



THE CAMBRIDGE GLASS COMPANY, CAMBRIDGE, OHIO, U. S. A.

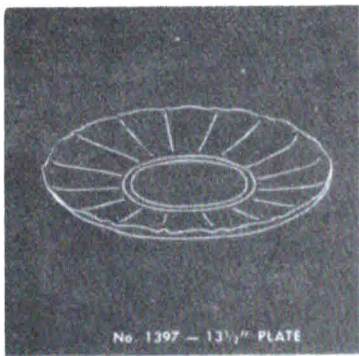

No. 1397 — 13 1/2" PLATE



No. 1491 — 4-PIECE
TWIN SALAD DRESSING SET

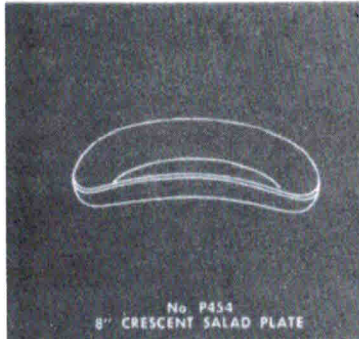

No. P454
8" CRESCENT SALAD PLATE



No. 103
7" 3-PART BOX AND COVER

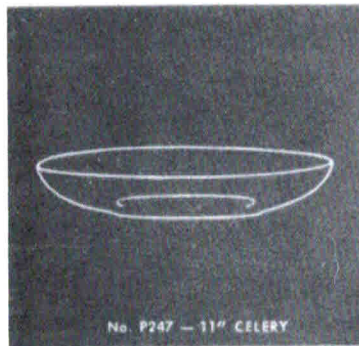

No. P247 — 11" CELERY



No. P101
32 OZ COCKTAIL SHAKER



No. 3700 — GOBLET



No. P212
10" 5-PART CELERY AND RELISH

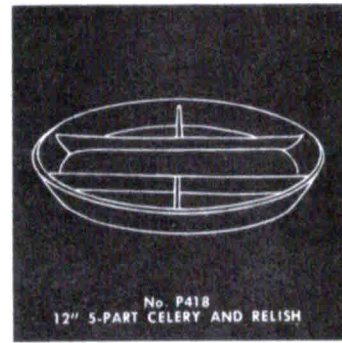

No. P418
12" 5-PART CELERY AND RELISH

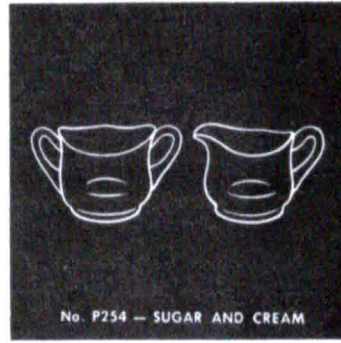

No. P254 — SUGAR AND CREAM



No. 3900/114
32 OZ. MARTINI JUG



No. 3900/117 — 20 OZ. JUG

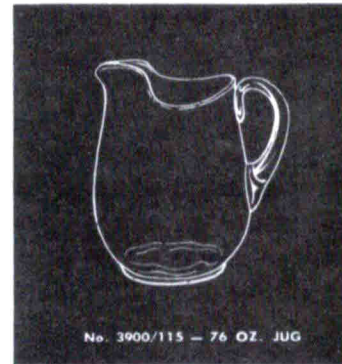

No. 3900/115 — 76 OZ. JUG



No. 3700
5 OZ. FOOTED TUMBLER

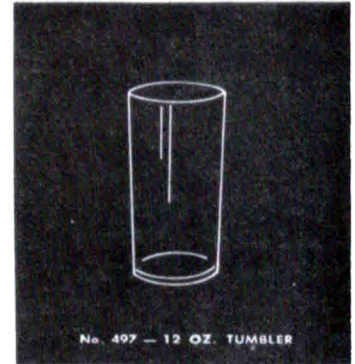

No. 497 — 12 OZ. TUMBLER



THE CAMBRIDGE GLASS COMPANY, CAMBRIDGE, OHIO, U. S. A.

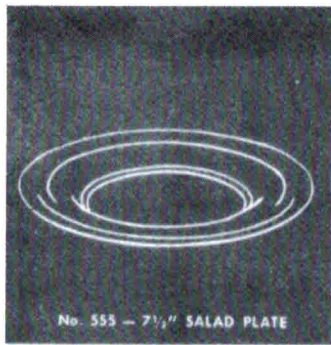

No. 555 - 7 1/2" SALAD PLATE



No. 1613 - HURRICANE LAMP



No. 3700 - TALL SHERBET

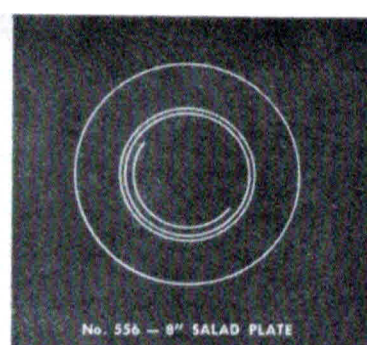

No. 556 - 8" SALAD PLATE



No. 3700 - LOW SHERBET



No. 3700
4 1/2 OZ. OYSTER COCKTAIL



No. 3700
10 OZ. FOOTED TUMBLER

No. 3700 - LOW SHERBET

King Edward

No. 821

ROCK CRYSTAL ENGRAVED



No. 3700 - 1 OZ. CORDIAL



No. 3700
12 OZ. FOOTED ICE TEA



No. 3700
10 OZ. FOOTED TUMBLER



No. 3700 - 3 OZ. COCKTAIL

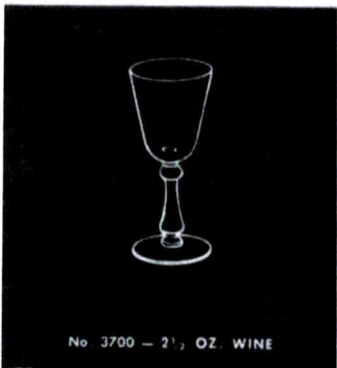

No. 3700 - 2 1/2 OZ. WINE



No. 3700 - 4 1/2 OZ. CLARET

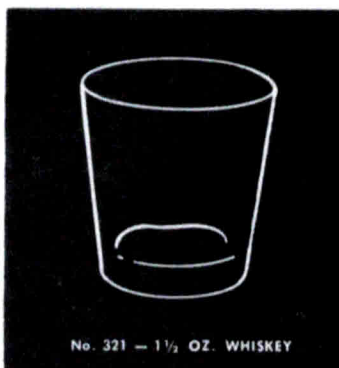

No. 321 - 1 1/2 OZ. WHISKEY



No. 321 - 7 OZ. O. F. COCKTAIL

Roses

No. 2P

+

Tomorrow

No. 8P

ROCK CRYSTAL ENGRAVED

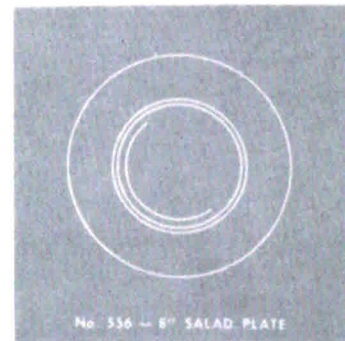
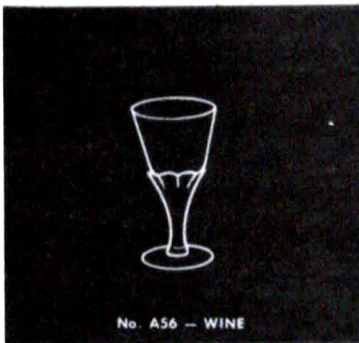
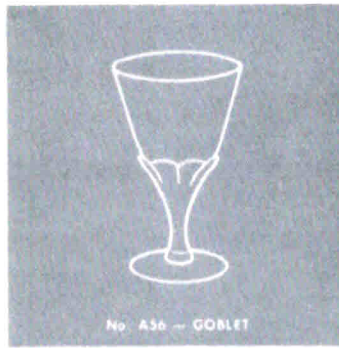



No. 966
2-PIECE COCKTAIL ICER



No. 3500 - LOW SHERBET

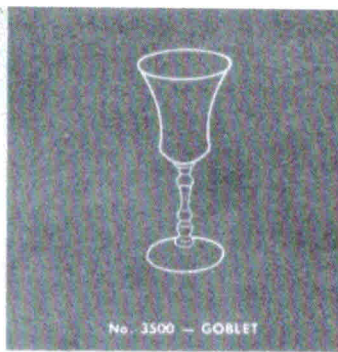

No. 3500 - GOBLET



No. 3500 - TALL SHERBET



No. 3500 - 3 OZ. COCKTAIL



No. 3500
12 OZ. FOOTED TUMBLER



No. 3500 - 2 1/2 OZ. WINE



No. 3500 - 4 1/2 OZ. CLARET

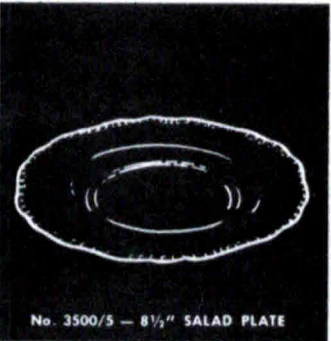

No. 3500/5 - 8 1/2" SALAD PLATE

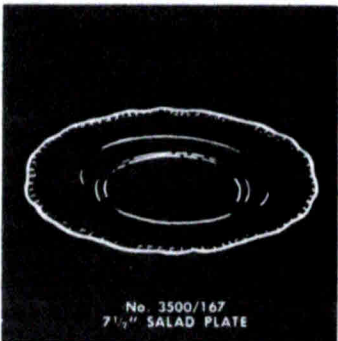

No. 3500/167
7 1/2" SALAD PLATE



No. 3500
4 1/2 OZ. OYSTER COCKTAIL



No. 3500 - 1 OZ. CORDIAL



No. 3500
10 OZ. FOOTED TUMBLER

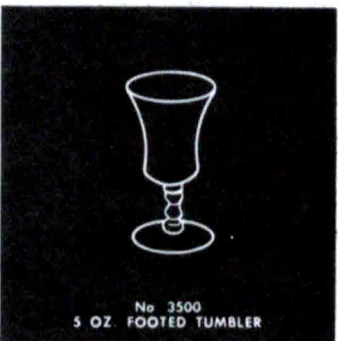

No. 3500
5 OZ. FOOTED TUMBLER



No. 3500 - 5 OZ. CAFE PARFAIT



No. 3500
10 OZ. FOOTED TUMBLER ADONIS

Croesus No. 722
+
Adonis No. 720

ROCK CRYSTAL ENGRAVED



No. 3500 - GOBLET CROESUS

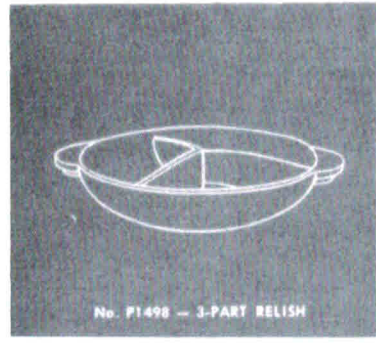
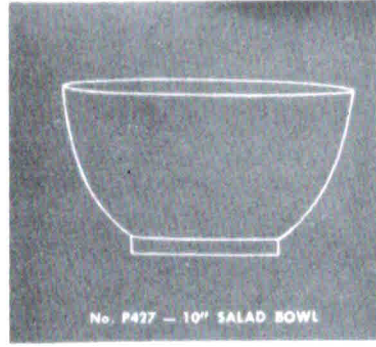
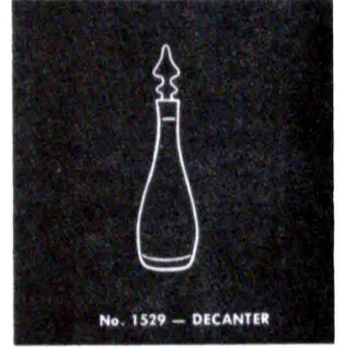
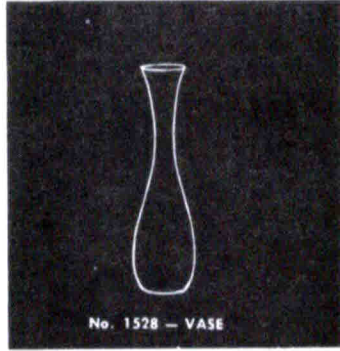
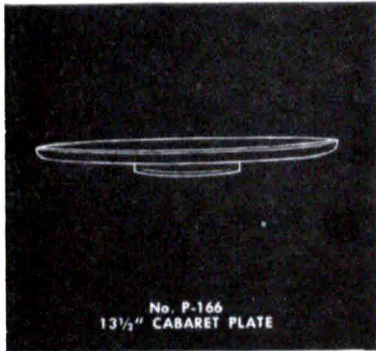

Wedding Rings

ROCK CRYSTAL ENGRAVED

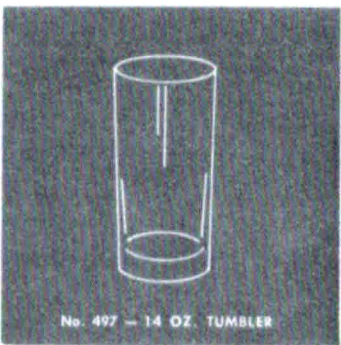
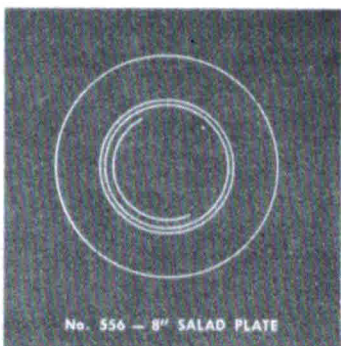
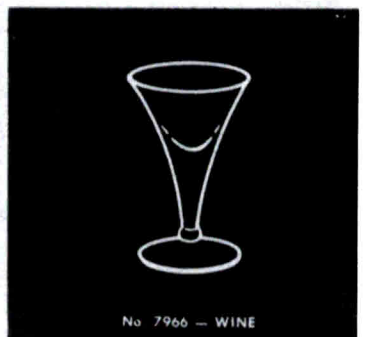
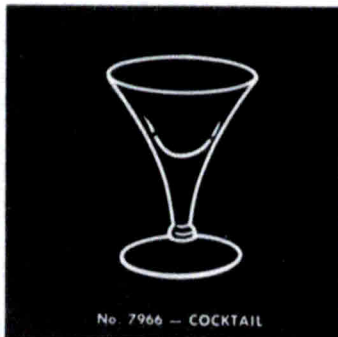
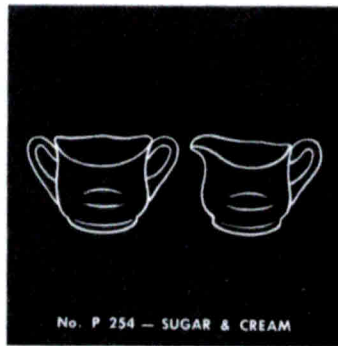
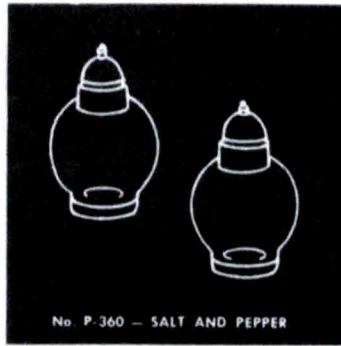
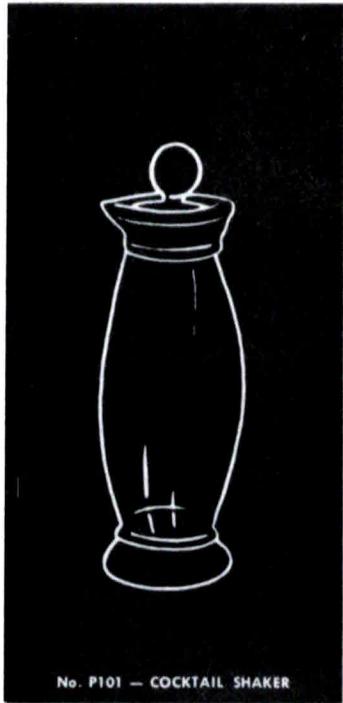

THE CAMBRIDGE GLASS COMPANY, CAMBRIDGE, OHIO, U.S.A.

Tempo

No. 1029

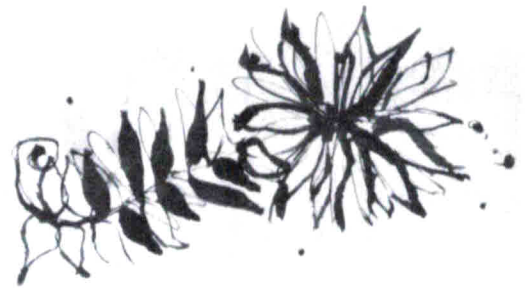

ROCK CRYSTAL ENGRAVED

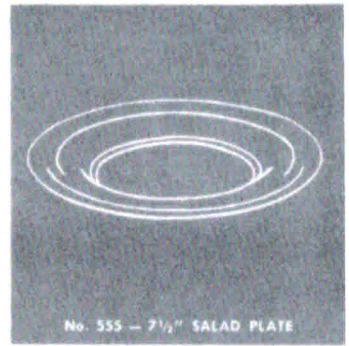

THE CAMBRIDGE GLASS COMPANY, CAMBRIDGE, OHIO, U. S. A.

ROCK CRYSTAL ENGRAVED

No. 1030

Roxbury Stemware

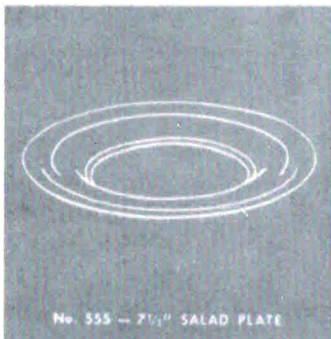
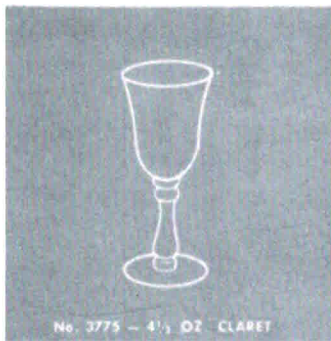
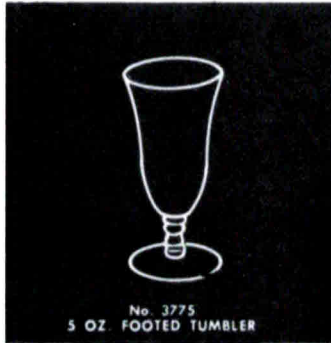

THE CAMBRIDGE GLASS COMPANY, CAMBRIDGE, OHIO, U. S. A.

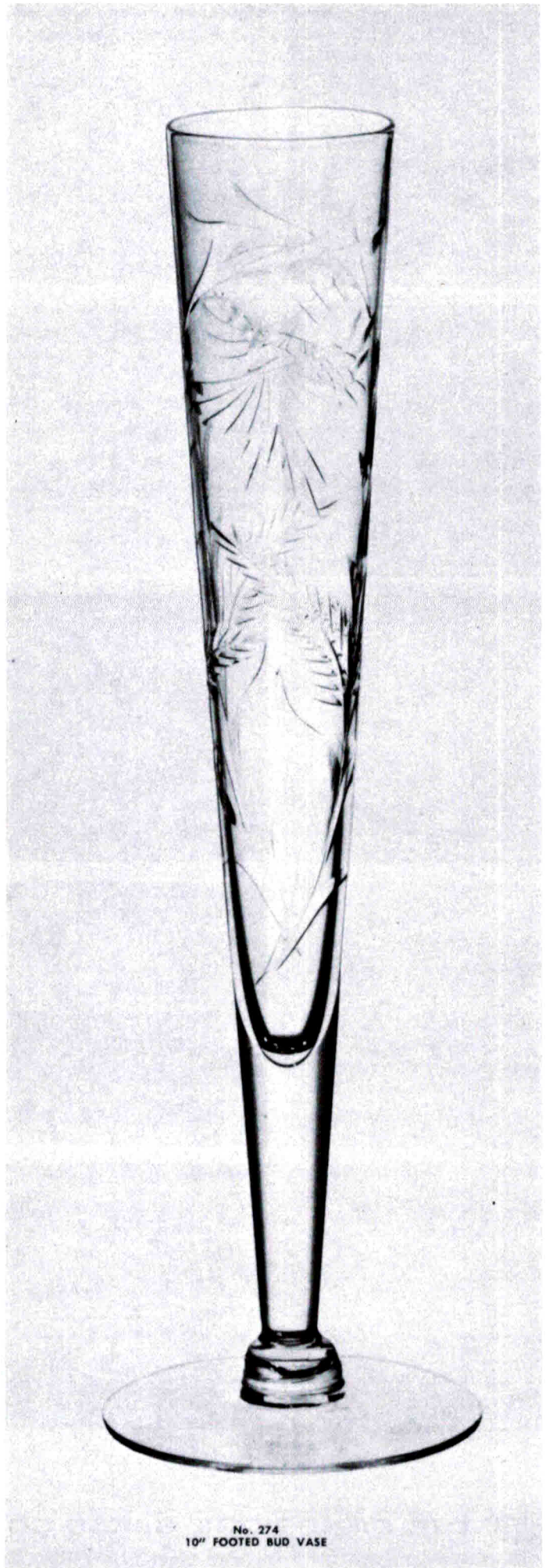
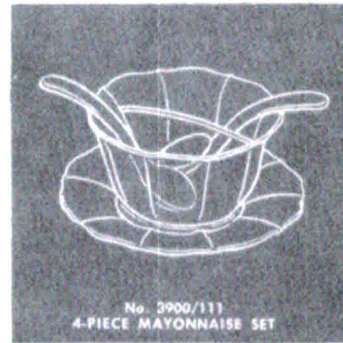
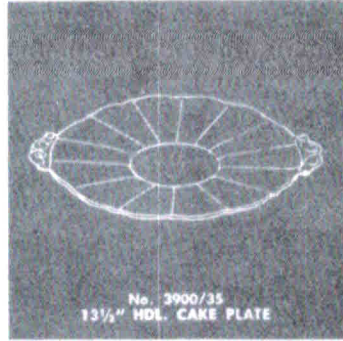
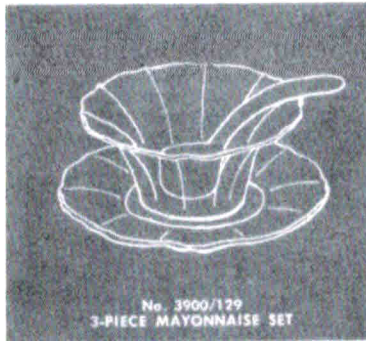
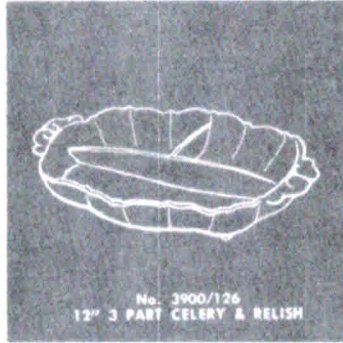
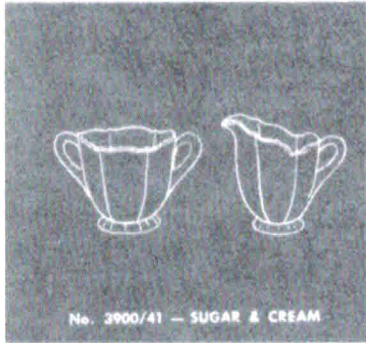

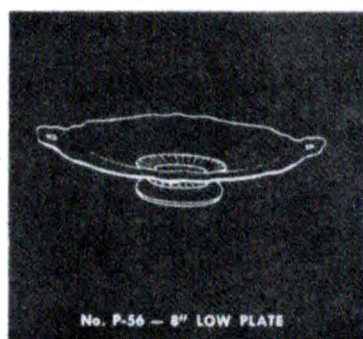
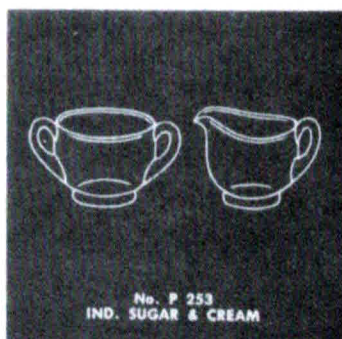
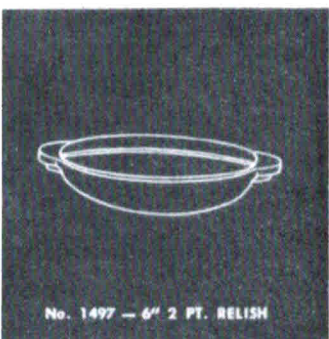
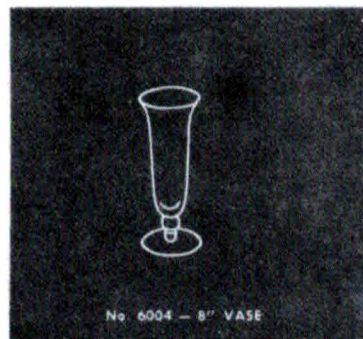
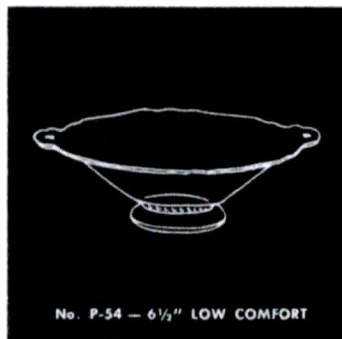
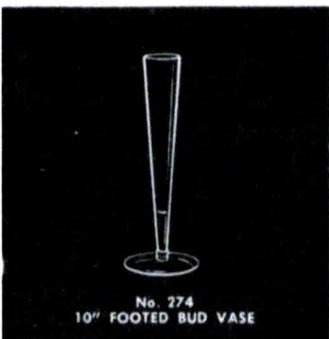
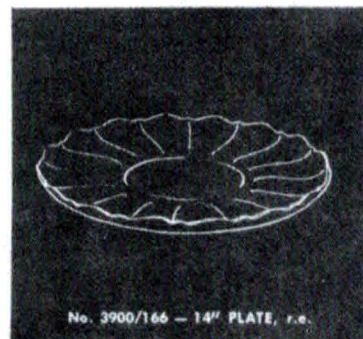

Tempo & Roxbury

ROCK CRYSTAL ENGRAVED



THE CAMBRIDGE GLASS COMPANY, CAMBRIDGE, OHIO, U. S. A.

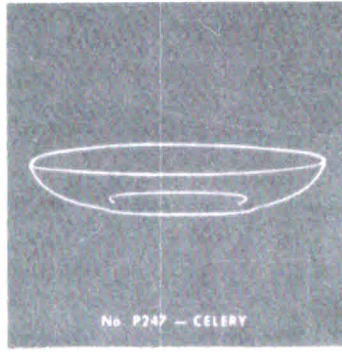
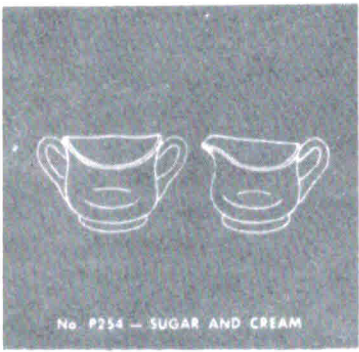

ROCK CRYSTAL ENGRAVED

No. 1081

Rondo

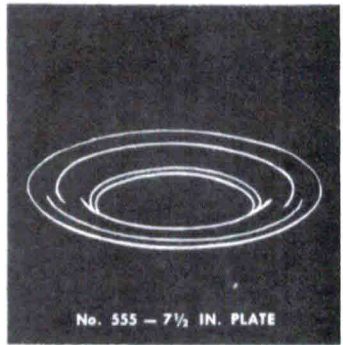
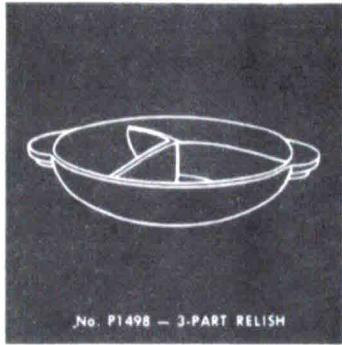
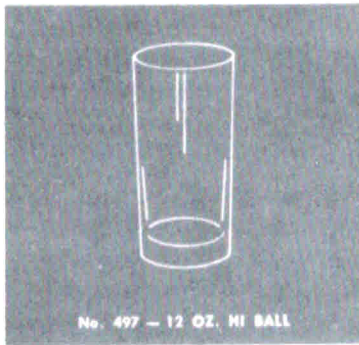
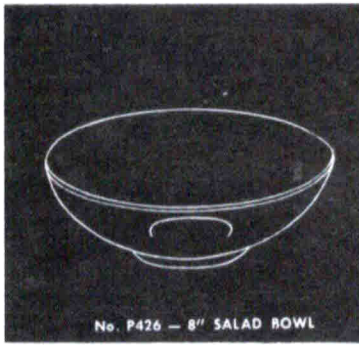
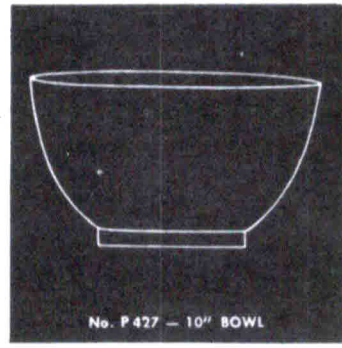
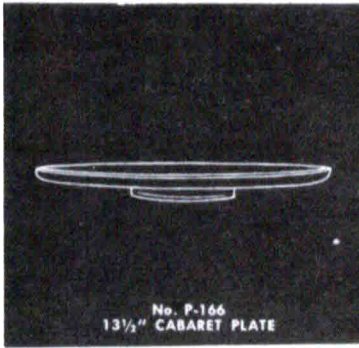

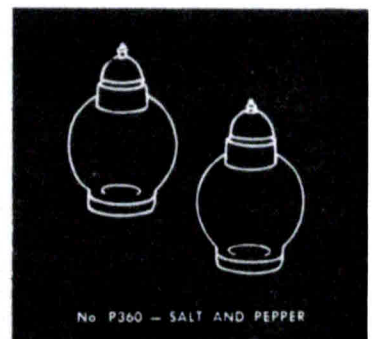
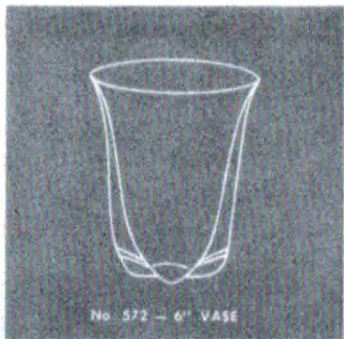
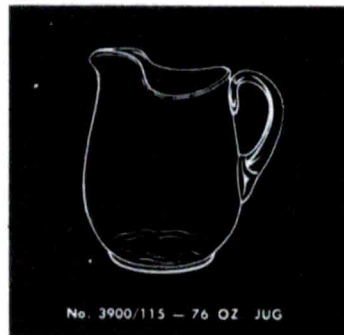
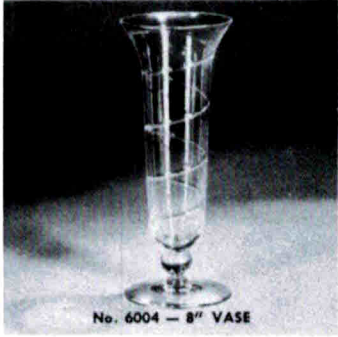
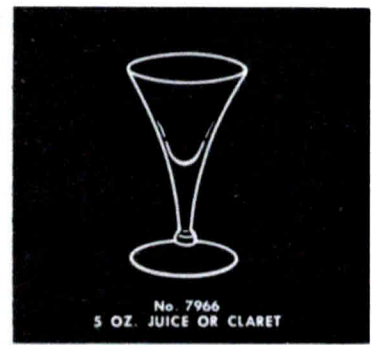
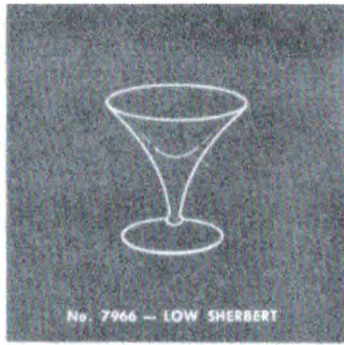

THE CAMBRIDGE GLASS COMPANY, CAMBRIDGE, OHIO, U. S. A.



No. 3700 - 9 OZ. GOBLET



No. 3700
6 OZ. TALL SHERBET



No. 3700 - 1 OZ. CORDIAL



No. 3700
12 OZ. FOOTED ICE TEA



No. 555 - 7 1/2" SALAD PLATE



No. 3700
6 OZ. LOW SHERBET



No. P-306 - 6" CANDY BOX
AND COVER (CUT KNOB)



No. 1532
3-PIECE MAYONNAISE SET



No. 3700 - 2 1/2 OZ. WINE



No. 3700
10 OZ. FOOTED TUMBLER



No. 3700 - 5" COMPORT

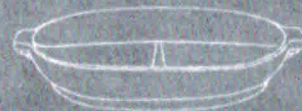

No. P-214 - 10" 3-PART RELISH



No. 3700
5 OZ. FOOTED TUMBLER



No. 3700 - 3 OZ. COCKTAIL



No. 3700 - 9 OZ. GOBLET



No. P-430 - 1" BOWL, FLARED

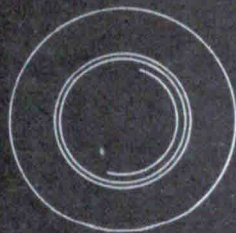

No. 556 - 8" SALAD PLATE



No. 3700 - 4 1/2 OZ. CLARET

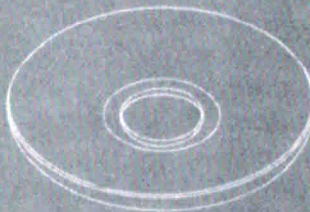

No. P-166 - 13 1/2" PLATE, r.e.

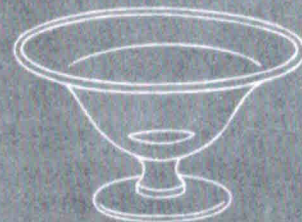

No. 533 - 5 1/2" COMPORT

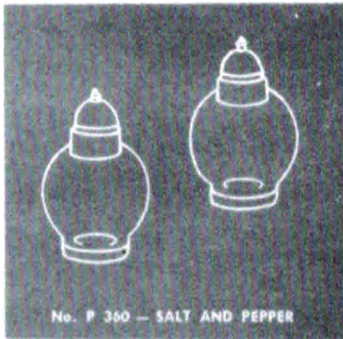
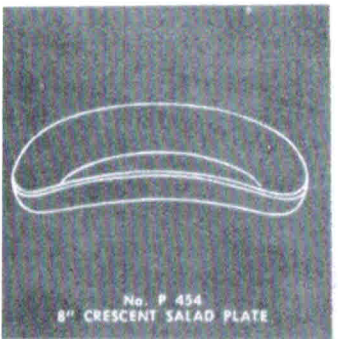
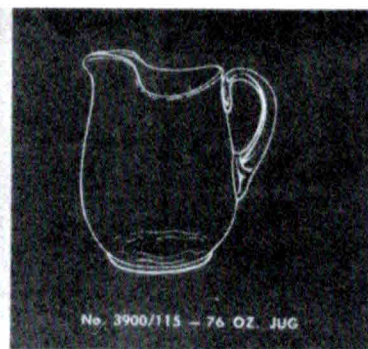
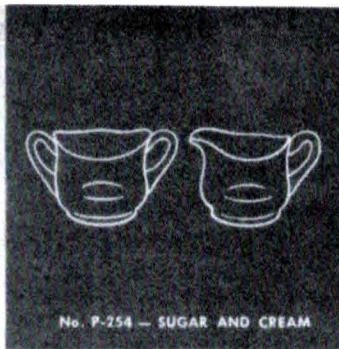
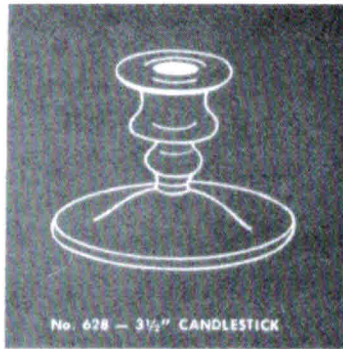

Laurel Wreath

ROCK CRYSTAL ENGRAVED



THE CAMBRIDGE GLASS COMPANY, CAMBRIDGE, OHIO, U. S. A.

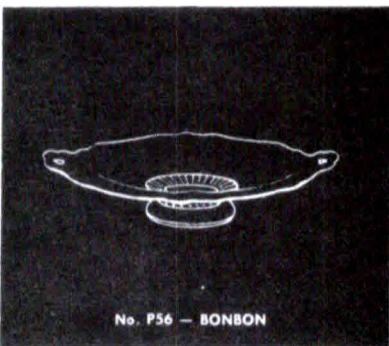
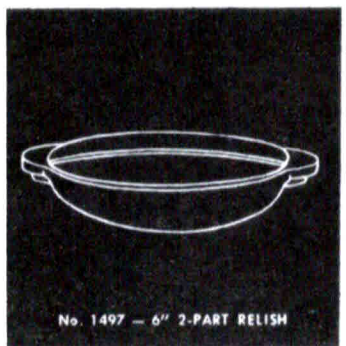
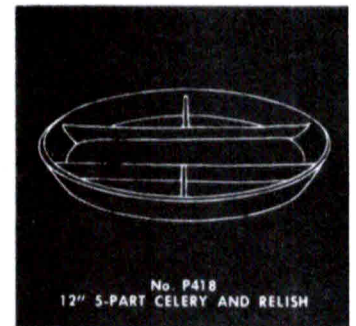
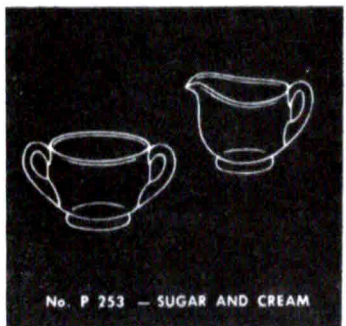
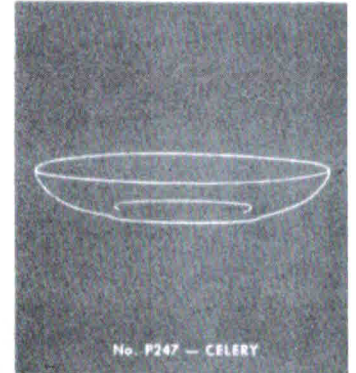
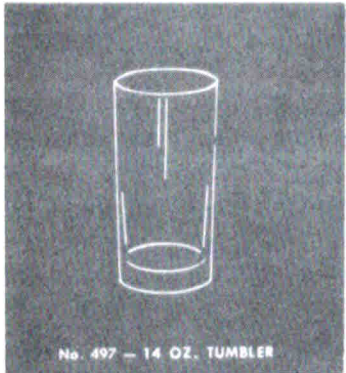
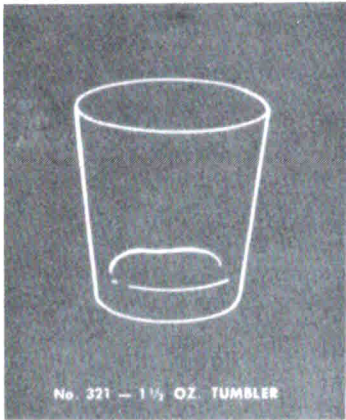

Laurel Wreath

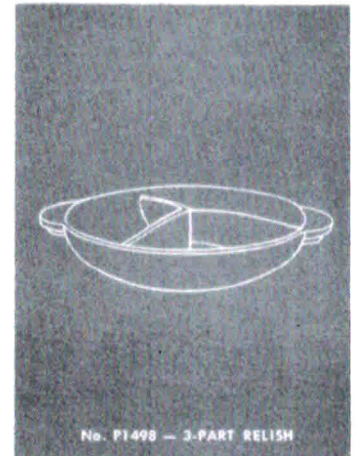
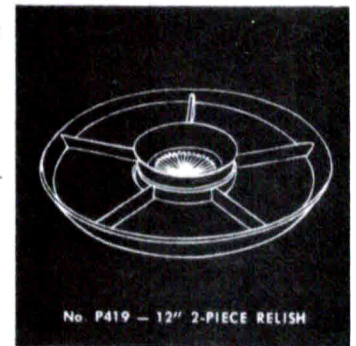

Star & Cadet

ROCK CRYSTAL ENGRAVED

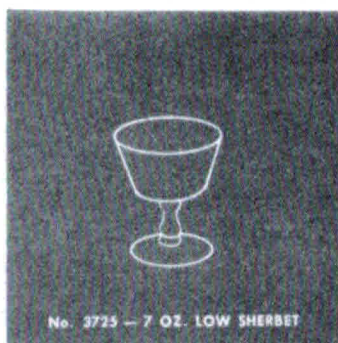
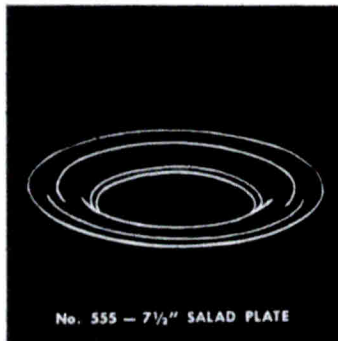
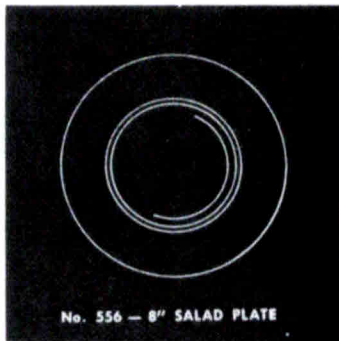
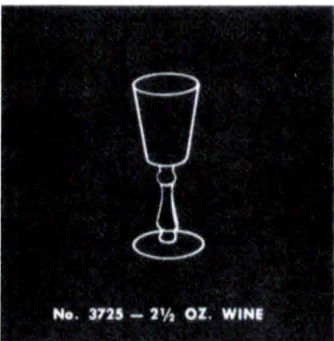
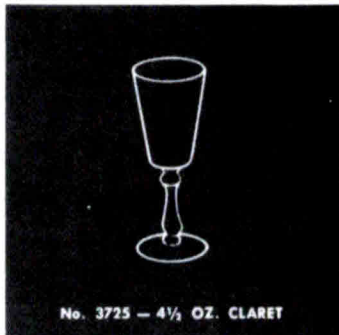
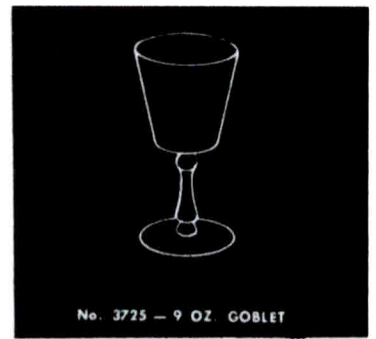

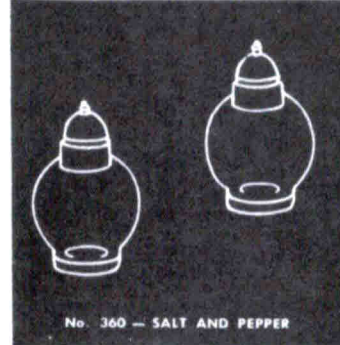
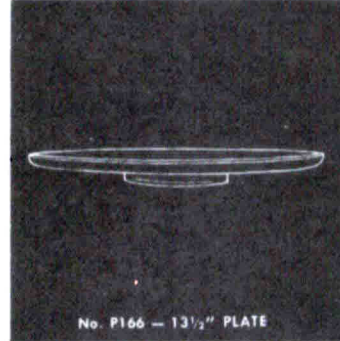
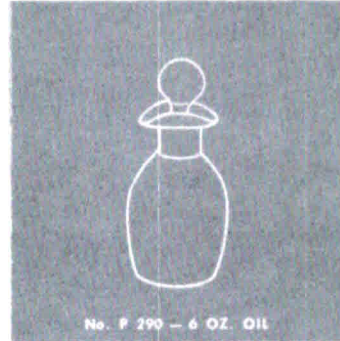
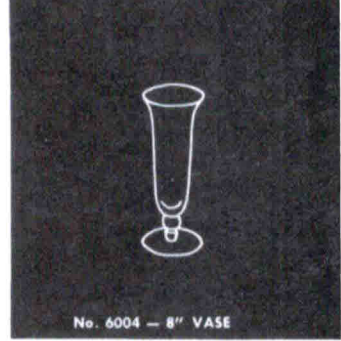
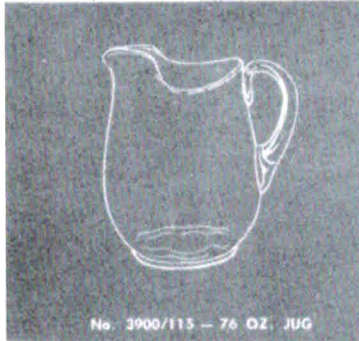
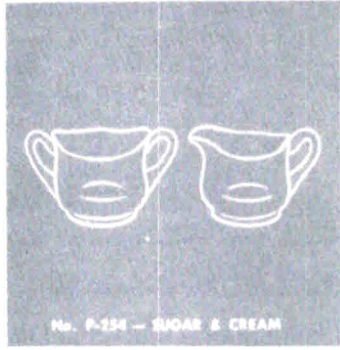

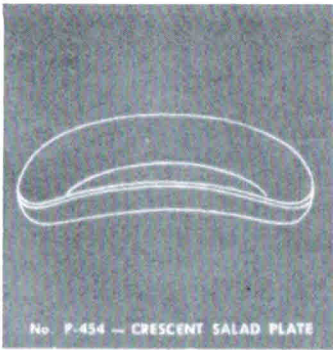

No. P-454 — CRESCENT SALAD PLATE

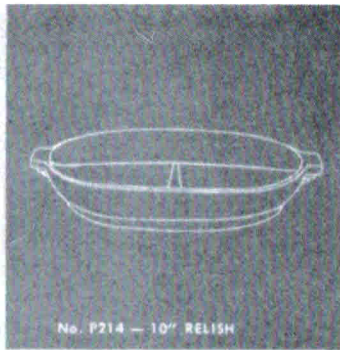

No. P214 — 10" RELISH



No. 3790
5 OZ. FOOTED TUMBLER



No. 3790 — CORDIAL

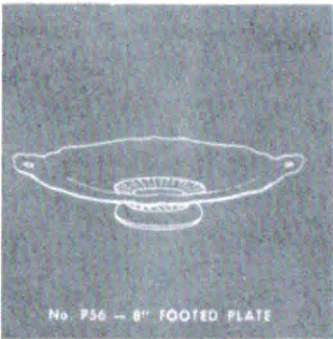

No. P56 — 8" FOOTED PLATE

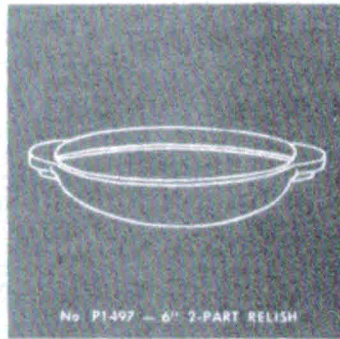

No. P1497 — 6" 2-PART RELISH



No. 3790 — OYSTER COCKTAIL



No. 3790 — WINE

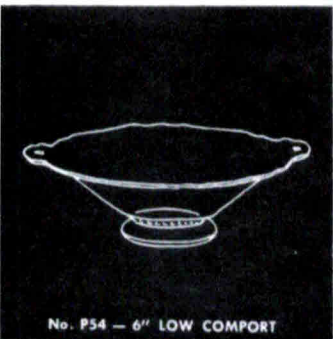

No. P54 — 6" LOW COMFORT

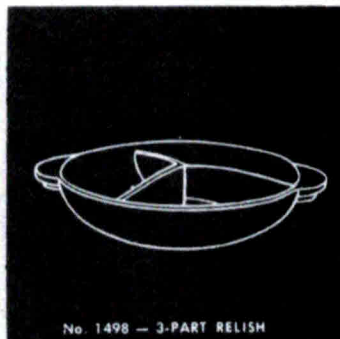

No. 1498 — 3-PART RELISH



No. 3790 — SHERRY

No. 3790 — WINE



No. 1180
1 1/2" 2-HANDLE BONBON

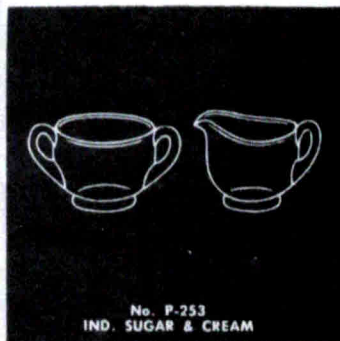

No. P-253
IND. SUGAR & CREAM



No. 3700 — COMFORT

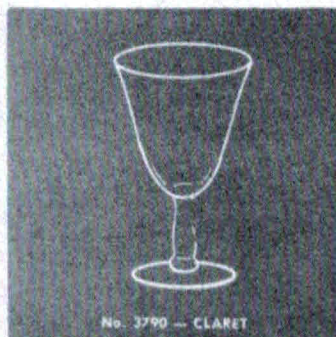

No. 3790 — CLARET

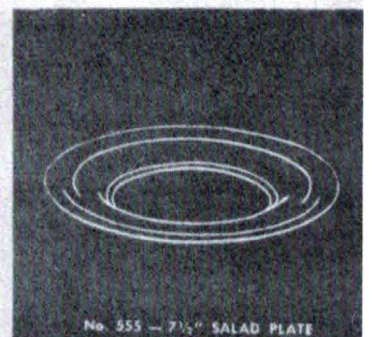

No. 555 — 7 1/2" SALAD PLATE

Lynbrook

ROCK CRYSTAL ENGRAVED

Harvest

No. 1053

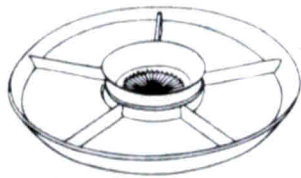

No. P419 — 12" 2-PIECE RELISH

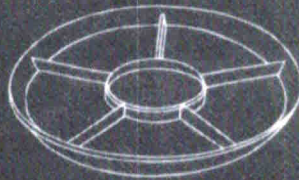

No. P 418
12" 5 PT. CELERY AND RELISH



No. 3900/170
12" 5-PART CELERY AND RADISH



No. 278 — 11" FTD VASE

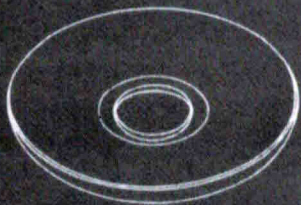

No. P 430 — 12" FLOWER BOWL

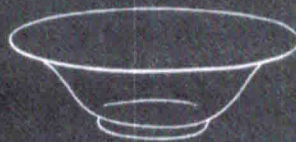

No. P 430 — 12" FLOWER BOWL

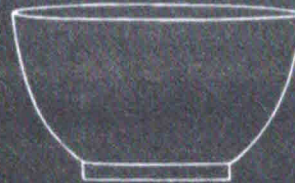

No. P 427 — 10" SALAD BOWL

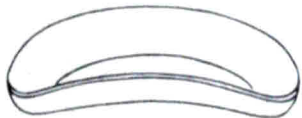

No. P 454
8" CRESCENT SALAD PLATE

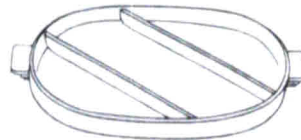

No. P-215
12" 3-PART RELISH TRAY

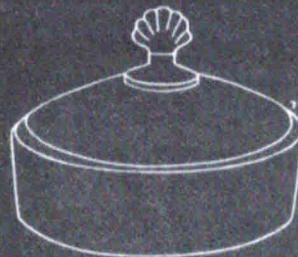

No. 103
7" 3 PT. CANDY BOX AND COVER



No. P 254 — SUGAR AND CREAM

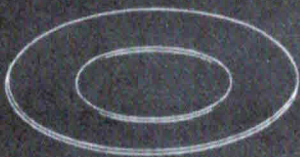

No. P 125 — 14" PLATE

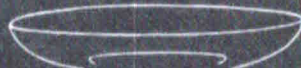

No. P 247 — CELERY



No. 1491
4 PC. TWIN SALAD DRESSING SET



No. P 212
10" 5 PT. CELERY AND RELISH

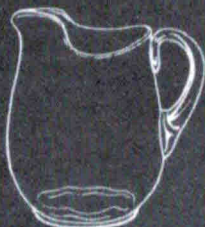

No. 3900/115 — 76 OZ. JUG



No. 3900/114
37 OZ. MARTINI JUG



No. P 499
CALLA LILY CANDLESTICK



No. 647
6" 2-LITE CANDLESTICK



No. 3750 — GOBLET



No. 3750 — TALL SHERBET



No. 3750 — WINE



No. 3750 — LOW SHERBET



No. 3750 — OYSTER COCKTAIL



No. 3750
12 OZ. FOOTED ICE TEA



No. 3750 — CORDIAL



No. 3750 — CLARET



No. 1613 — HURRICANE LAMP

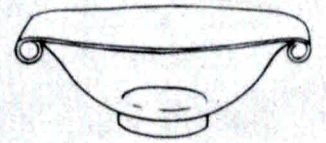

No. P 384 — 11" OVAL BOWL

No. 1053 Harvest

ROCK CRYSTAL ENGRAVED



No. 3750
5 OZ. FOOTED TUMBLER

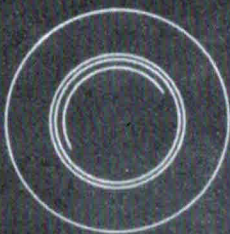

No. 535 — 7 1/2" SALAD PLATE
No. 536 — 8" SALAD PLATE



No. 3750 — WINE

No. 3750 — GOBLET

No. 3750 — TALL SHERBET



No. P 306
CANDY BOX AND COVER

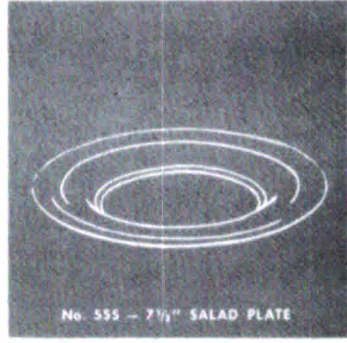
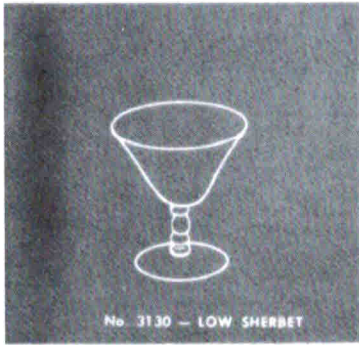

No. 1028
Glendale
ROCK CRYSTAL ENGRAVED



THE CAMBRIDGE GLASS COMPANY, CAMBRIDGE, OHIO, U. S. A.



No. 3790 — GOBLET CROWN



No. 3790
12 OZ FOOTED TUMBLER



No. 3790 — COCKTAIL



No. 3790 — WINE



No. 3790 — CORDIAL



No. 3790
5 OZ FOOTED TUMBLER

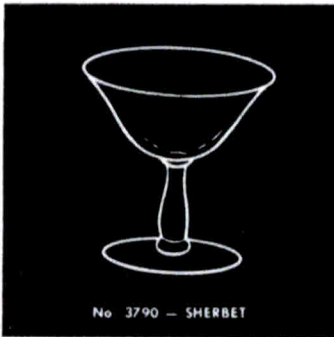

No. 3790 — SHERBET

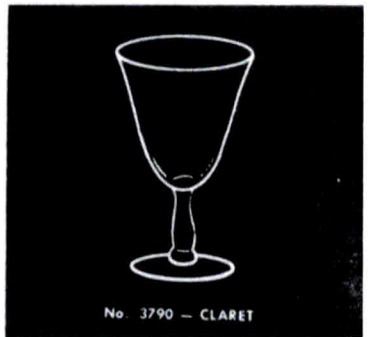

No. 3790 — CLARET

ROCK CRYSTAL ENGRAVED

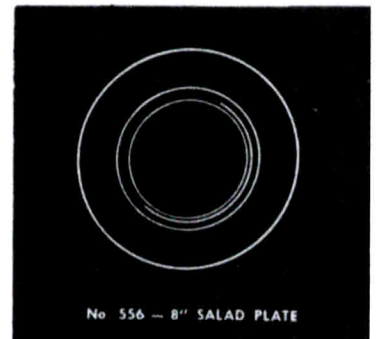

No. 556 — 8" SALAD PLATE



No. 3790 — GOBLET ORION

Crown No. 6P
 &
Orion No. 1P

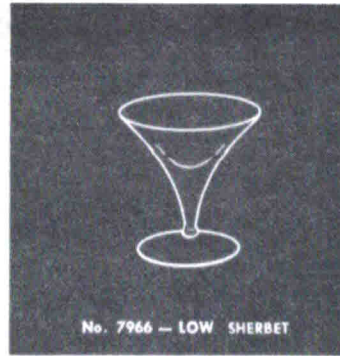
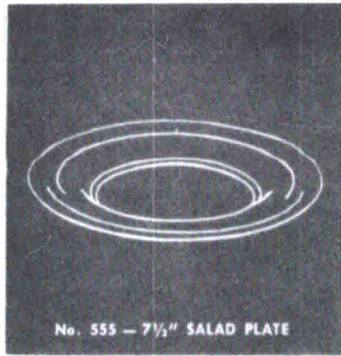

No. 1093 Flame

ROCK CRYSTAL ENGRAVED



No. 3P Flight

ROCK CRYSTAL ENGRAVED

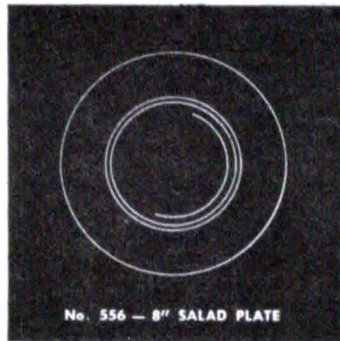

THE CAMBRIDGE GLASS COMPANY, CAMBRIDGE, OHIO, U. S. A.

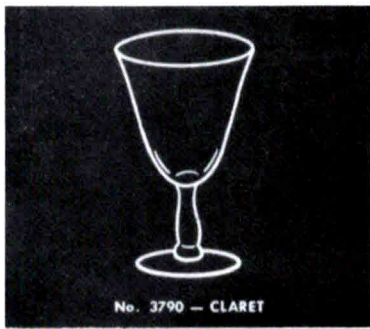

No. 3790 — CLARET



No. 3790 — CORDIAL



No. 3790 — WINE

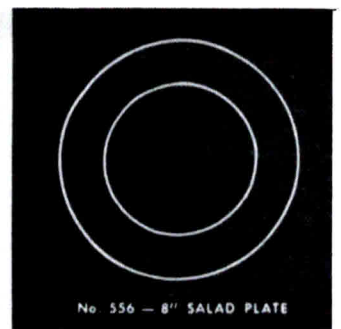

No. 556 — 8" SALAD PLATE

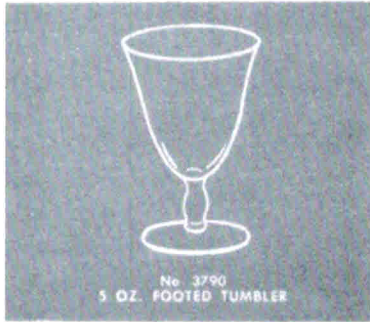

No. 3790
5 OZ. FOOTED TUMBLER



No. 3790
12 OZ. FOOTED TUMBLER



No. 3790 — SHERBET

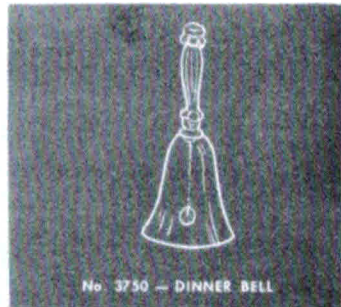

No. 3750 — DINNER BELL



No. 3790 — GOBLET STARBURST



No. 3790 — GOBLET STARLITE



No. 3790 — GOBLET



No. 3790 — COCKTAIL

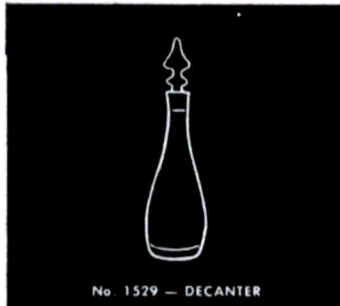

No. 1529 — DECANTER

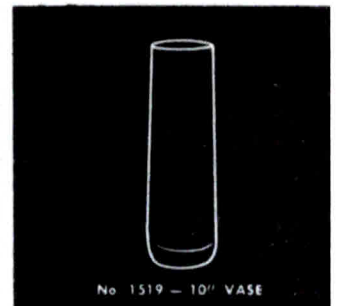

No. 1519 — 10" VASE

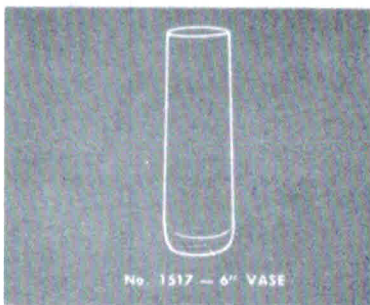

No. 1517 — 6" VASE

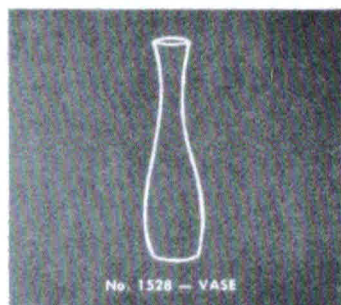

No. 1528 — VASE

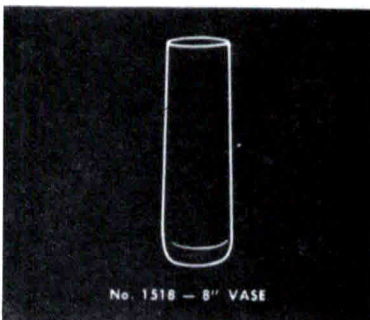

No. 1518 — 8" VASE

Starlite No. 10P
+

No. 4P
Starburst

ROCK CRYSTAL
ENGRAVED

Old English

No. 10

ROCK CRYSTAL ENGRAVED



No. 1953 - GOBLET

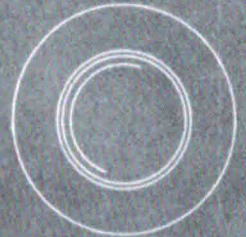

No. 556 - 8" SALAD PLATE



No. 1953 - COCKTAIL



No. 1953 - 5 OZ. FTD TUMBLER



No. 1953 - SHERBET



No. 1953 - 12 OZ. FTD TUMBLER

Old Master

ROCK CRYSTAL ENGRAVED



No. 1953 - GOBLET OLD MASTER



No. 1953 - GOBLET OLD ENGLISH



No. 3790 — CORDIAL

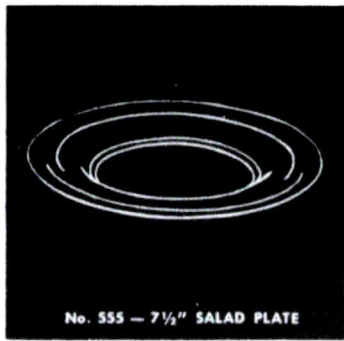

No. 555 — 7 1/2" SALAD PLATE

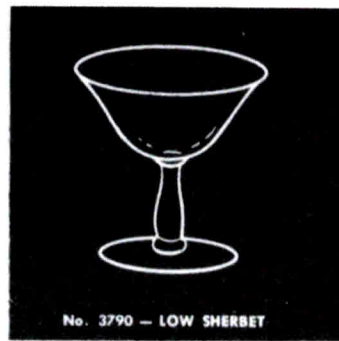

No. 3790 — LOW SHERBET

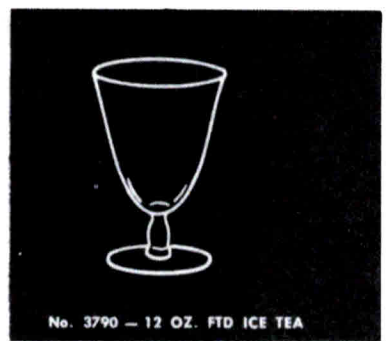

No. 3790 — 12 OZ. FTD ICE TEA

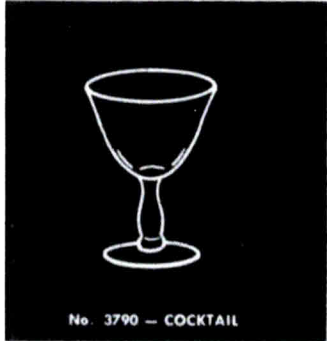

No. 3790 — COCKTAIL



No. 3790 — WINE



No. 3790 — 5 OZ. FTD TUMBLER

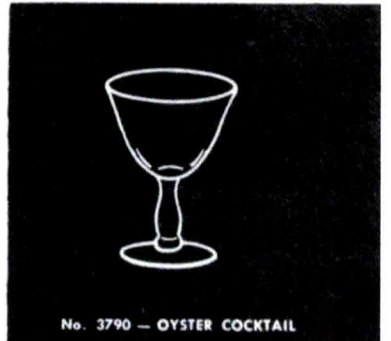

No. 3790 — OYSTER COCKTAIL

Festoon

No. 1071



No. 3790 — CLARET



No. 3790 — GOBLET FESTOON

ROCK CRYSTAL ENGRAVED



No. 3790 — COCKTAIL



DANUBE
No. 3790 12 OZ. FOOTED TUMBLER

Blue Danube

No. 32P

ROCK CRYSTAL ENGRAVED



No. 3790 — GOBLET



No. 3790 — 12 OZ. FTD TUMBLER

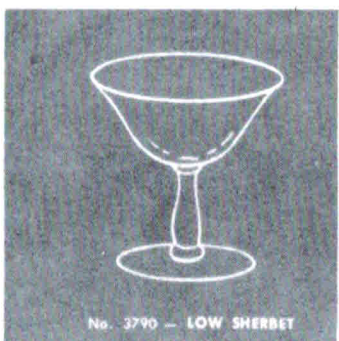

No. 3790 — LOW SHERBET

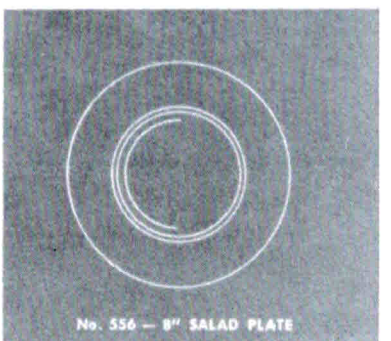

No. 556 — 8" SALAD PLATE

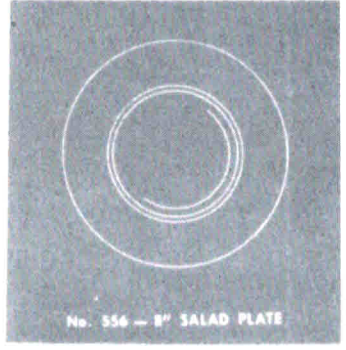
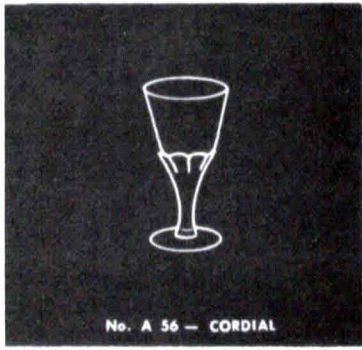

Formal

ROCK CRYSTAL ENGRAVED

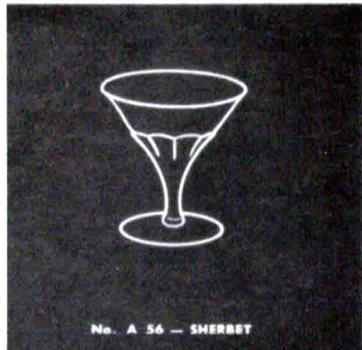
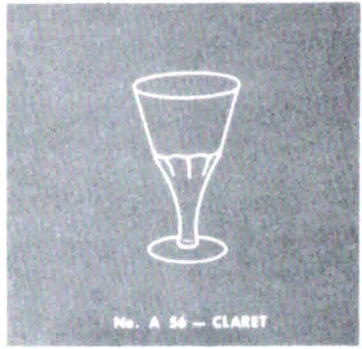



No. 7801 — 4 OZ. COCKTAIL

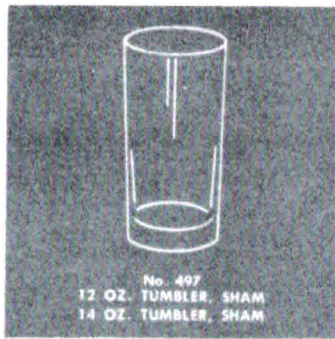

No. 497
12 OZ. TUMBLER, SHAM
14 OZ. TUMBLER, SHAM

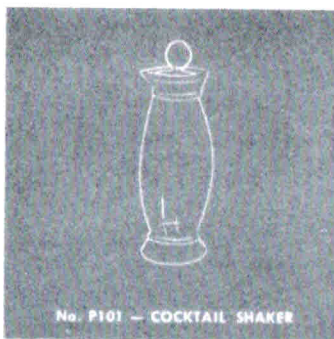

No. P101 — COCKTAIL SHAKER



No. 321 — 12 OZ. O. F. COCKTAIL



No. 321 — 9 OZ. O. F. COCKTAIL

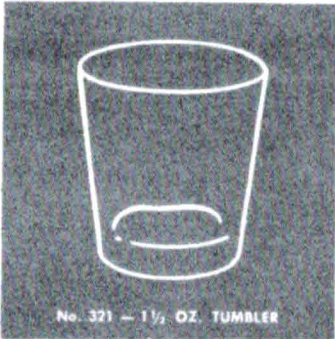

No. 321 — 1 1/2 OZ. TUMBLER

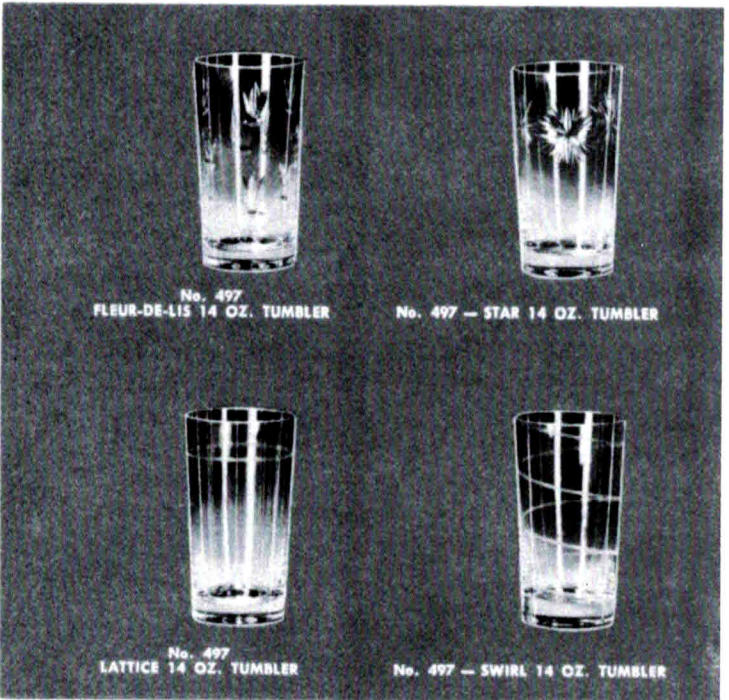

No. 497
FLEUR-DE-LIS 14 OZ. TUMBLER

No. 497 — STAR 14 OZ. TUMBLER

No. 497
LATTICE 14 OZ. TUMBLER

No. 497 — SWIRL 14 OZ. TUMBLER



STAR

FLEUR-DE-LIS

No. P-92 — 26 OZ. DECANTER



No. 7801
1 OZ. POUSSE CAFE



No. 3900/114
32 OZ. MARTINI JUG

Matched Barsemble

ROCK CRYSTAL ENGRAVED



No. 7801
5 OZ. WHISKEY SOUR

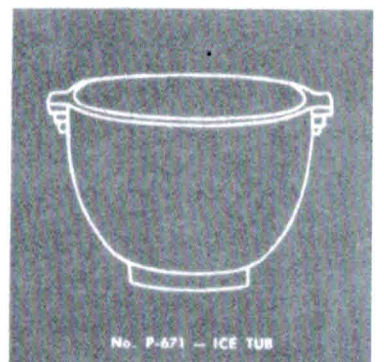

No. P-671 — ICE TUB



THE CAMBRIDGE GLASS COMPANY, CAMBRIDGE, OHIO, U.S.A.



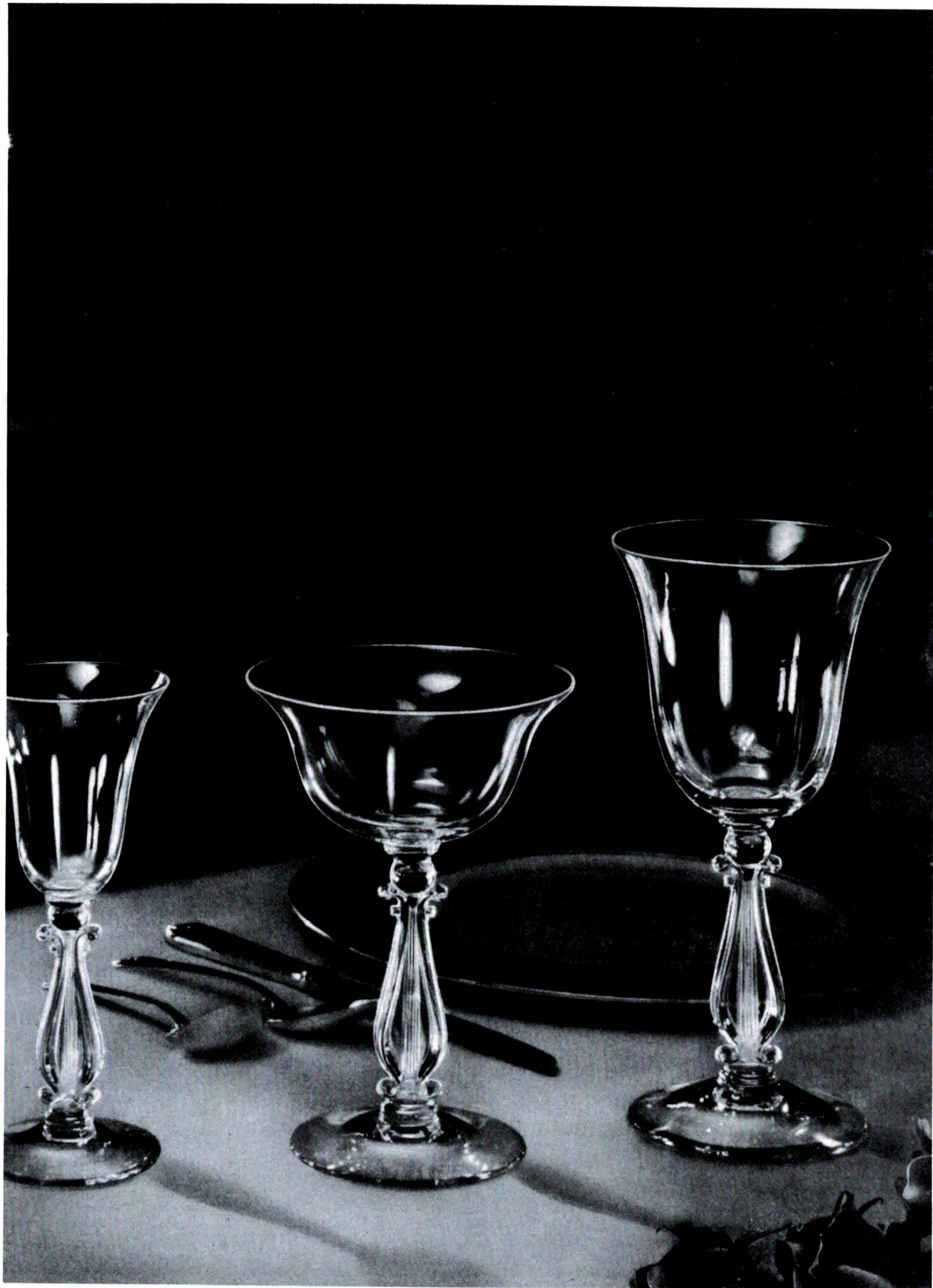

Cascade

No. 4000

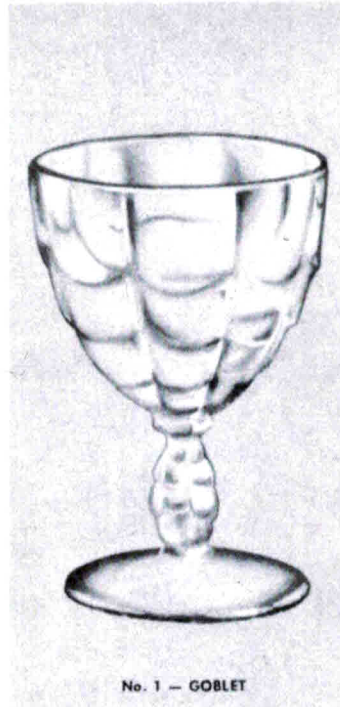
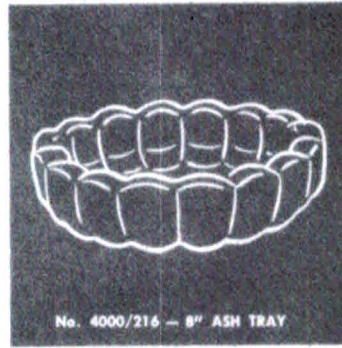
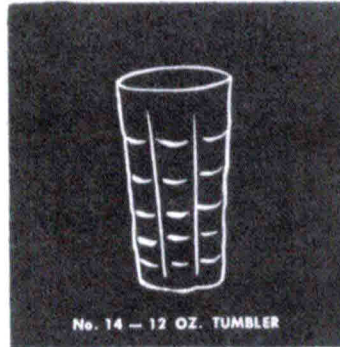

THE CAMBRIDGE GLASS COMPANY, CAMBRIDGE, OHIO, U. S. A.

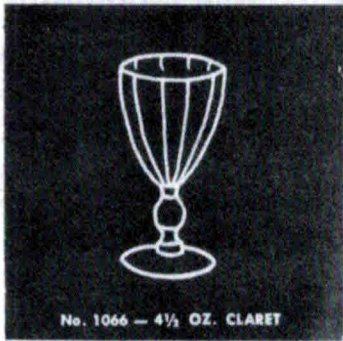
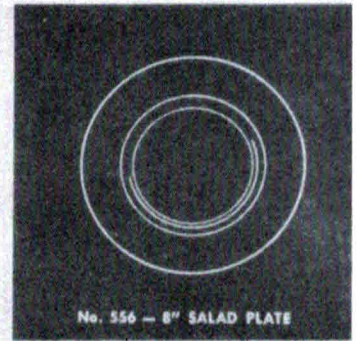
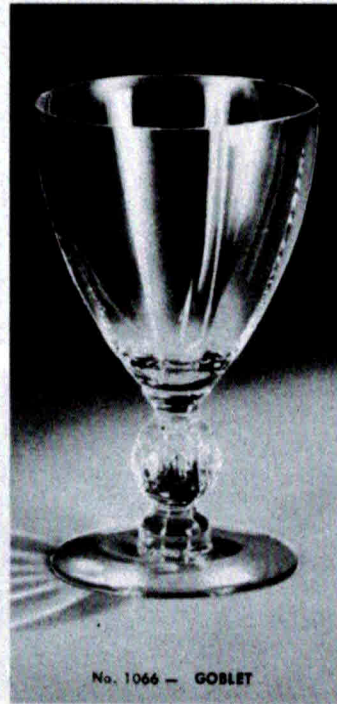

MANDARIN GOLD
EMERALD GREEN
AMBER
AMETHYST
CRYSTAL

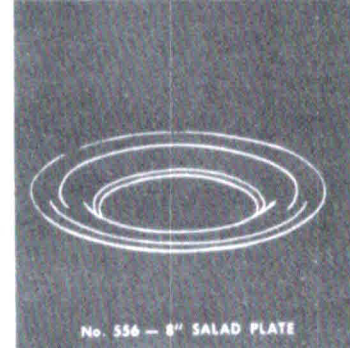

Allegro

No. 3795



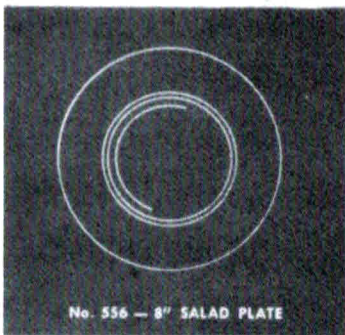
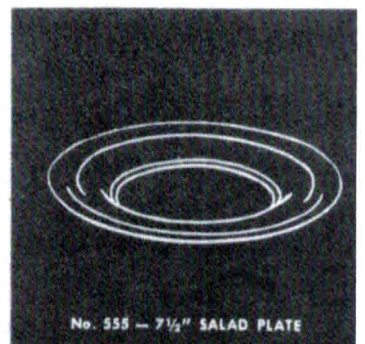

Castleton

No. 3725



THE CAMBRIDGE GLASS COMPANY, CAMBRIDGE, OHIO, U.S.A.

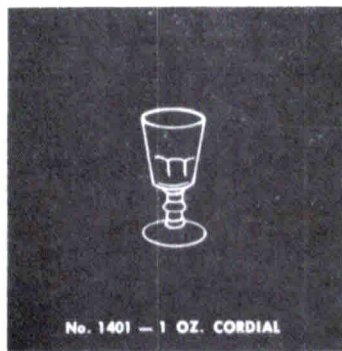

No. 1401 — 1 OZ. CORDIAL

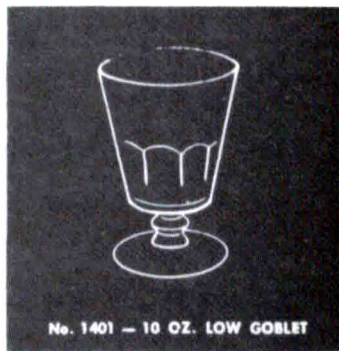

No. 1401 — 10 OZ. LOW GOBLET

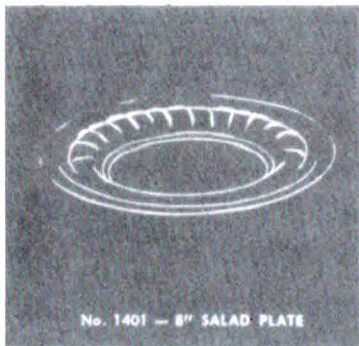

No. 1401 — 8" SALAD PLATE

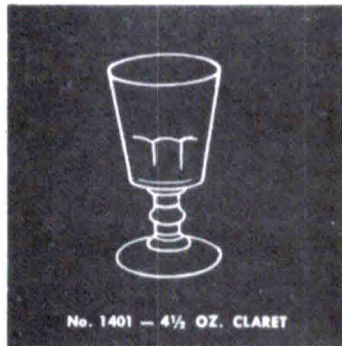

No. 1401 — 4½ OZ. CLARET

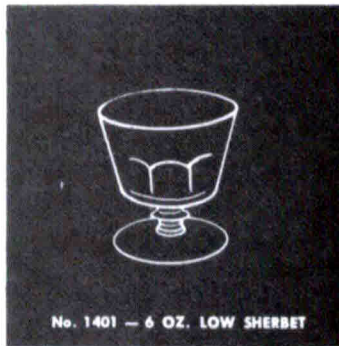

No. 1401 — 6 OZ. LOW SHERBET



No. 1401 — 10 OZ. TALL GOBLET



No. 1401
12 OZ. FOOTED ICE TEA

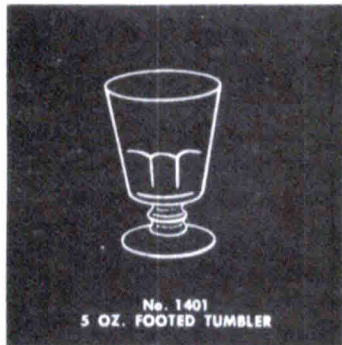

No. 1401
5 OZ. FOOTED TUMBLER



No. 1401 — 10 OZ. TALL GOBLET

Jefferson

No. 1401

MANDARIN GOLD
EMERALD
CRYSTAL



No. 1401
3½ OZ. COCKTAIL OR WINE

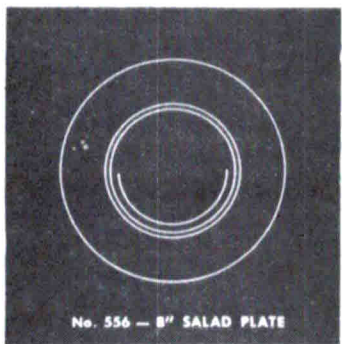

No. 556 — 8" SALAD PLATE



No. 1401 — 6 OZ. TALL SHERBET



THE CAMBRIDGE GLASS COMPANY, CAMBRIDGE, OHIO, U. S. A.



No. 27 - 3 OZ. WINE



No. 55 - 2 OZ. TUMBLER

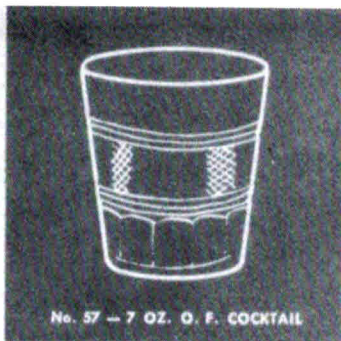

No. 57 - 7 OZ. O. F. COCKTAIL



No. 59 - 14 OZ. TUMBLER



No. 56 - 5 OZ. TUMBLER



No. 87
1 OZ. FOOTED CORDIAL



No. 58 - 10 OZ. TUMBLER



No. 51 - 10 OZ. TABLE TUMBLER



No. 2 - 6 1/2 OZ. TALL SHERBET



No. 20
12 OZ. FOOTED TUMBLER

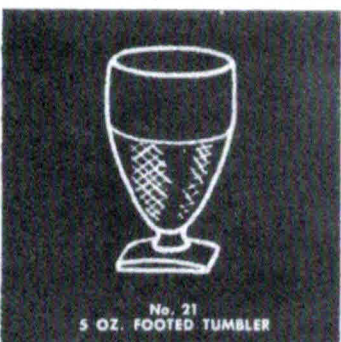

No. 21
5 OZ. FOOTED TUMBLER



No. 26 - 3 1/2 OZ. COCKTAIL

Mount Vernon



No. 1 - 10 OZ. GOBLET

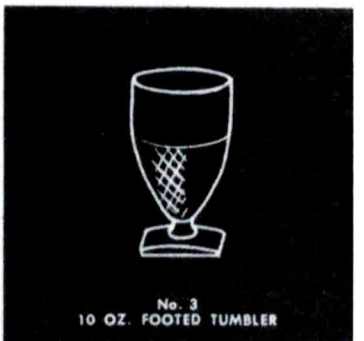

No. 3
10 OZ. FOOTED TUMBLER

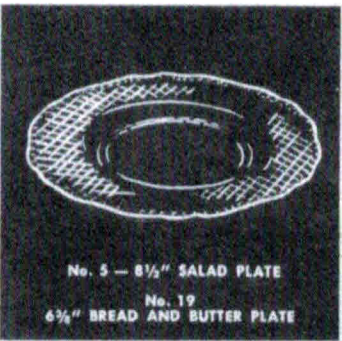

No. 5 - 8 1/2" SALAD PLATE

No. 19
6 3/4" BREAD AND BUTTER PLATE

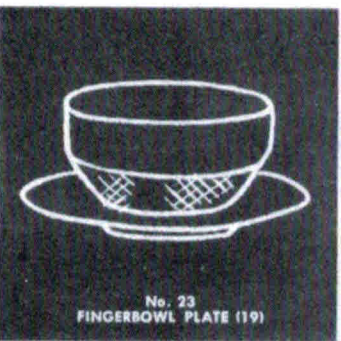

No. 23
FINGERBOWL PLATE (19)

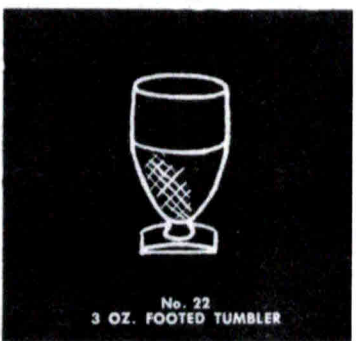

No. 22
3 OZ. FOOTED TUMBLER

Regency

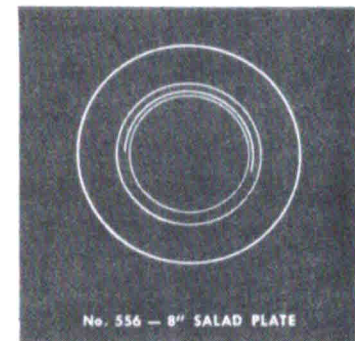
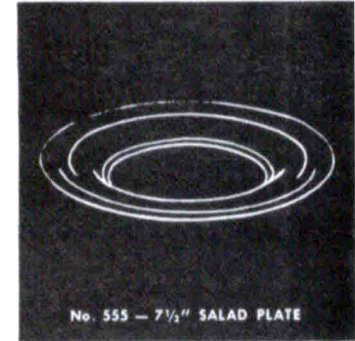

THE CAMBRIDGE GLASS COMPANY, CAMBRIDGE, OHIO, U. S. A.



No. 3500 — 3 OZ. COCKTAIL



No. 3500 — 2 1/2 OZ. LOW WINE



No. 3500
10 OZ. FOOTED TUMBLER



No. 3500
5 OZ. FOOTED TUMBLER



No. 3500
4 1/2" OYSTER COCKTAIL

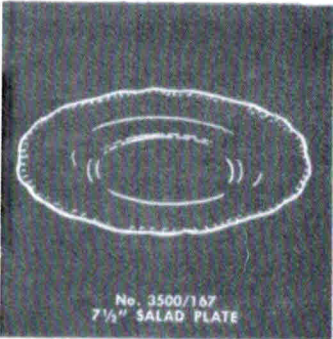

No. 3500/167
7 1/2" SALAD PLATE

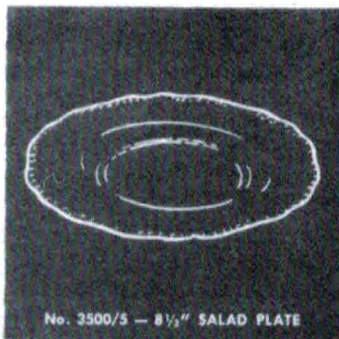

No. 3500/5 — 8 1/2" SALAD PLATE



No. 3500 — 7 OZ. TALL SHERBET



No. 3500
12 OZ. FOOTED TALL ICE TEA



No. 3500 — 2 1/2 OZ. WINE



No. 3500 — 7 OZ. LOW SHERBET



No. 3500 — 10 OZ. GOBLET

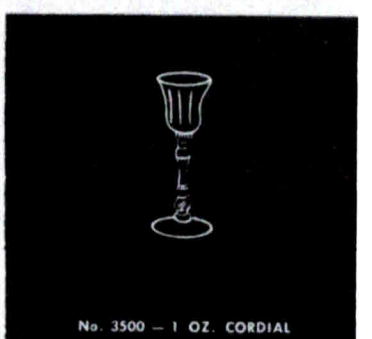

No. 3500 — 1 OZ. CORDIAL



No. 3500 — 5 OZ. CAFE PARFAIT



No. 3500 — 4 1/2 OZ. CLARET

Gadroon

No. 3500

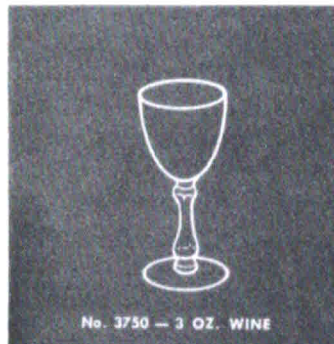

Charleston
No. 3750

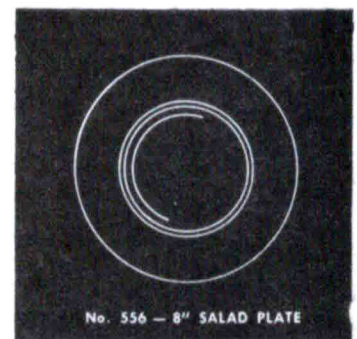
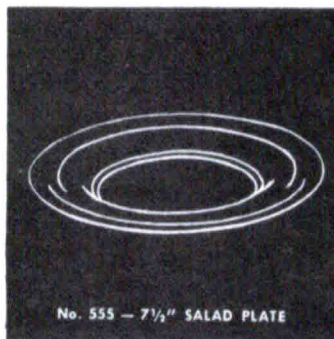

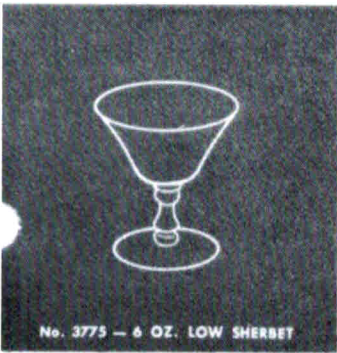

No. 3775 - 6 OZ. LOW SHERBET



No. 3775 - 6 OZ. TALL SHERBET



No. 3775 - 10 OZ. GOBLET



No. 3775 - 3 OZ. COCKTAIL



No. 3775
4 1/2 OZ. OYSTER COCKTAIL



No. 3775 - 1 OZ. CORDIAL

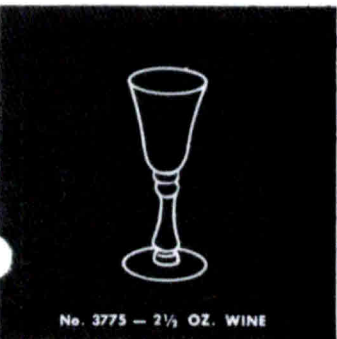

No. 3775 - 2 1/2 OZ. WINE

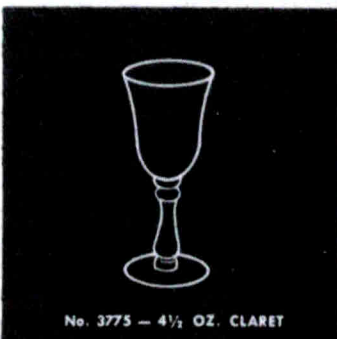

No. 3775 - 4 1/2 OZ. CLARET

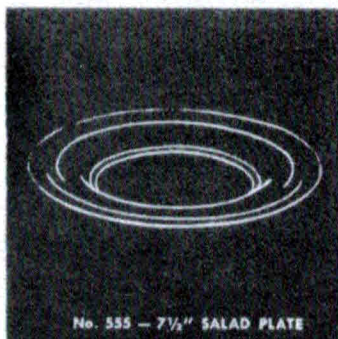

No. 555 - 7 1/2" SALAD PLATE

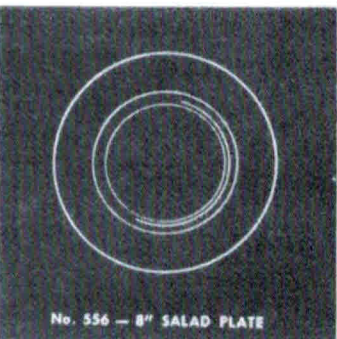

No. 556 - 8" SALAD PLATE



No. 3775
12 OZ. FOOTED ICE TEA



No. 3775 - 10 OZ. GOBLET



No. 3775
10 OZ. FOOTED TUMBLER



No. 3775
5 OZ. FOOTED TUMBLER

Arlington

No. 3775



THE CAMBRIDGE GLASS COMPANY, CAMBRIDGE, OHIO, U.S.A.

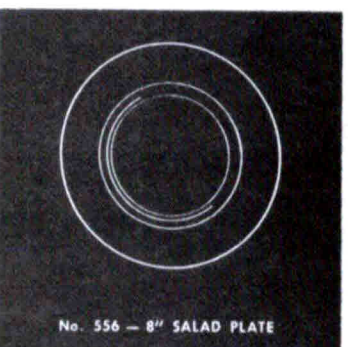
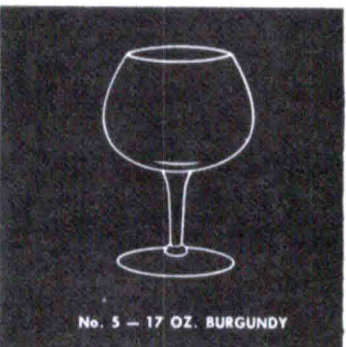
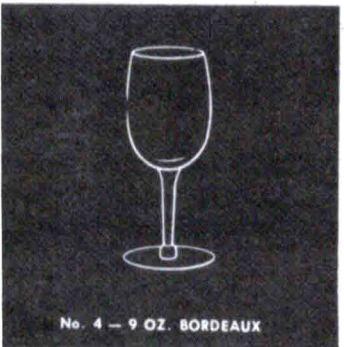
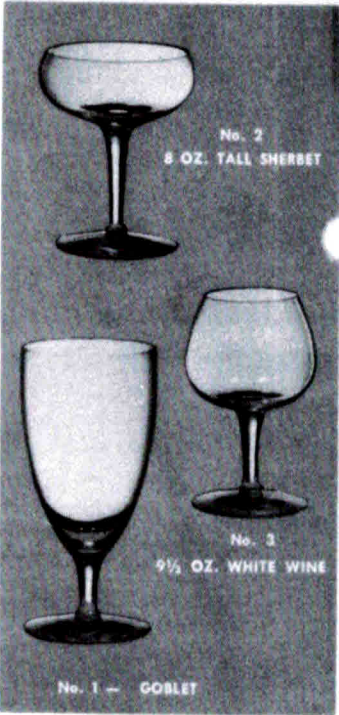
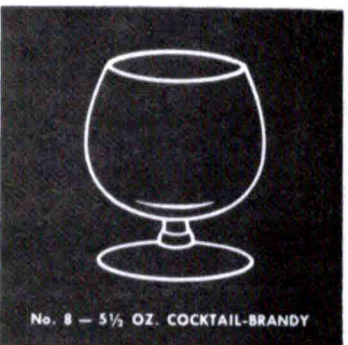
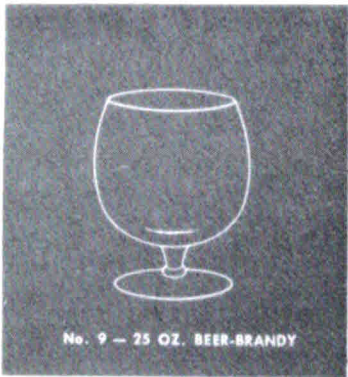

Connoisseur Line

MADE IN CRYSTAL



THE CAMBRIDGE GLASS COMPANY, CAMBRIDGE, OHIO, U.S.A.

Heirloom

MADE IN CRYSTAL

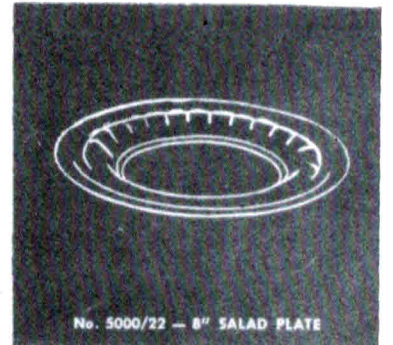
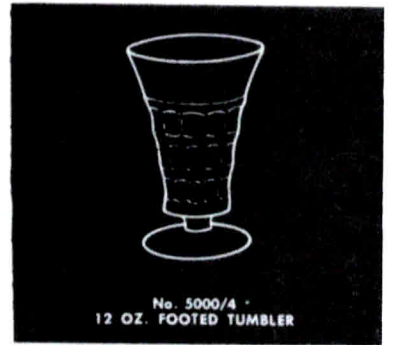
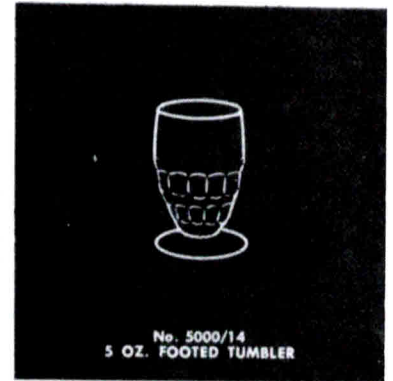
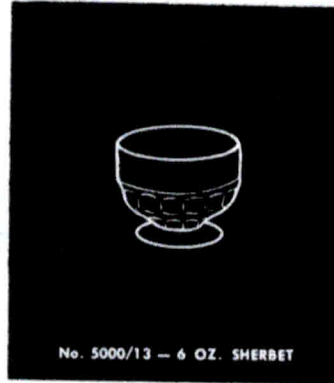
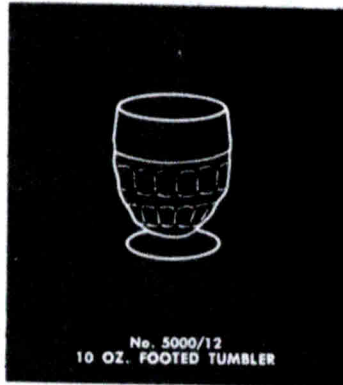
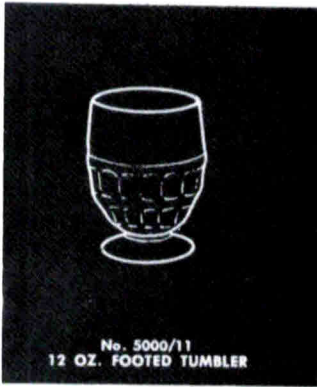

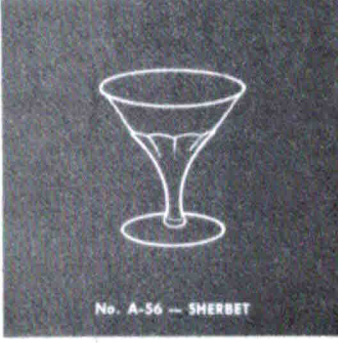
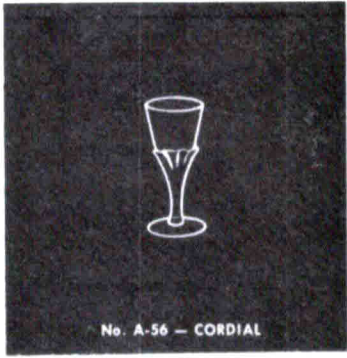

Today

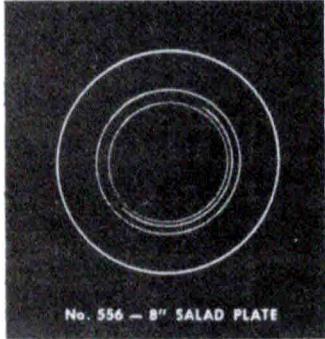

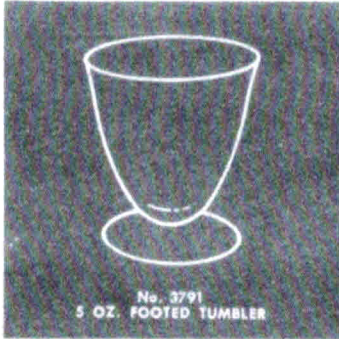
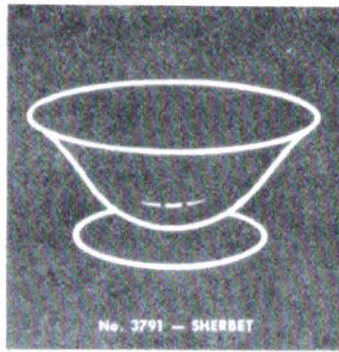
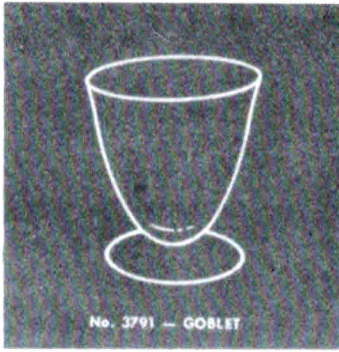

Invitation

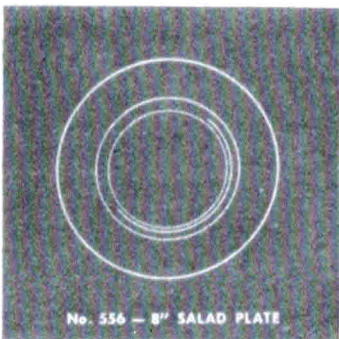

 THE CAMBRIDGE GLASS COMPANY, CAMBRIDGE, OHIO, U. S. A.

3109 Line



No. 3109 — 9 OZ. GOBLET



No. 3109 — 6 OZ. TALL SHERBET



No. 3109
12 OZ. FOOTED ICE TEA



No. 3109 — 9 OZ. GOBLET



No. 3109 — 4 OZ. CLARET



No. 3109 — 3 1/2 OZ. COCKTAIL



No. 3109 — 6 OZ. LOW SHERBET



No. 3109
5 OZ. FOOTED TUMBLER



No. 3109 — 3 OZ. WINE

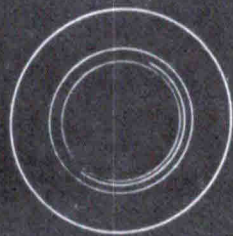

No. 556 — 8" SALAD PLATE

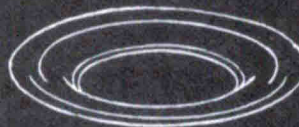

No. 555 — 7 1/2" SALAD PLATE



No. 3109 — 1 OZ. CORDIAL



No. 3109
4 1/2 OZ. OYSTER COCKTAIL

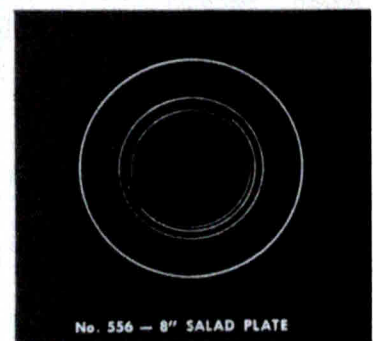
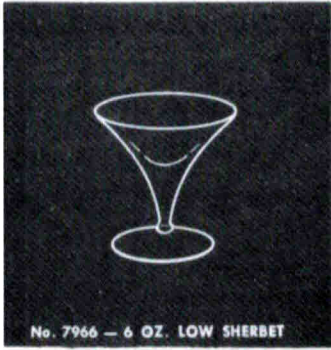
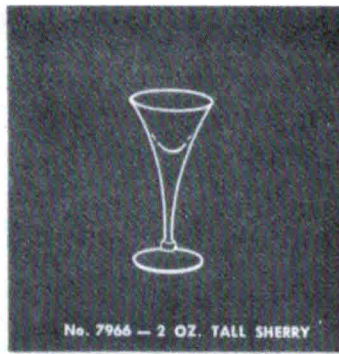

Trumpet



THE CAMBRIDGE GLASS COMPANY, CAMBRIDGE, OHIO, U. S. A.

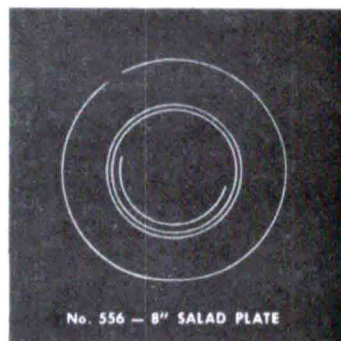
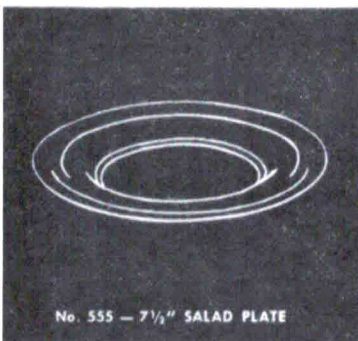
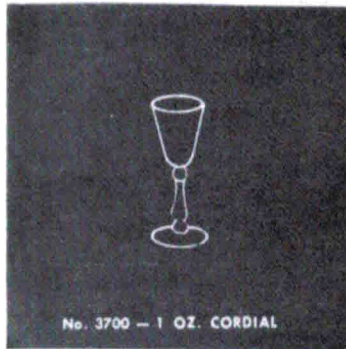
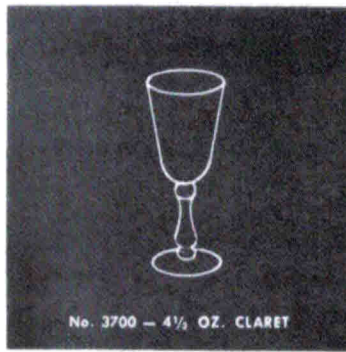
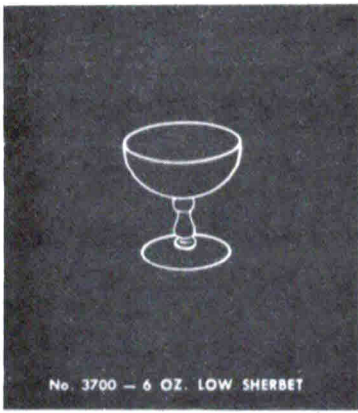

Dunkirk

No. 3700



THE CAMBRIDGE GLASS COMPANY, CAMBRIDGE, OHIO, U.S.A

3121 Line



No. 3121 - 2½ OZ. WINE



No. 3121
5 OZ. FOOTED TUMBLER



No. 3121 - 10 OZ. GOBLET

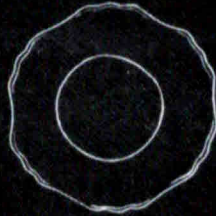

No. 3400/176
7½" SALAD PLATE



No. 3121 - 4½ OZ. CLARET



No. 3121 - 6 OZ. TALL SHERBET



No. 3121 - 6 OZ. LOW SHERBET



No. 3121
10 OZ. FOOTED TUMBLER



No. 3121
4½ OZ. OYSTER COCKTAIL



No. 3121 - COMPOTE



No. 3121 - 3 OZ. COCKTAIL



No. 3121 - 10 OZ. GOBLET



No. 3121 - 1 OZ. CORDIAL



No. 3121 - 5 OZ. CAFE PARFAIT



No. 3121 - 2½ OZ. LOW WINE



No. 3121
12 OZ. FOOTED ICE TEA

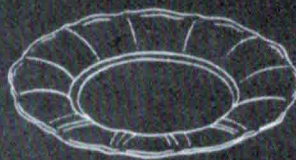

No. 3900/22
8" SALAD PLATE

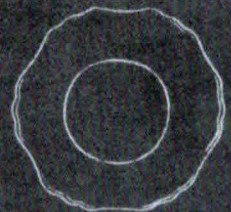

No. 3400/62
8½" SALAD PLATE

3139 Line

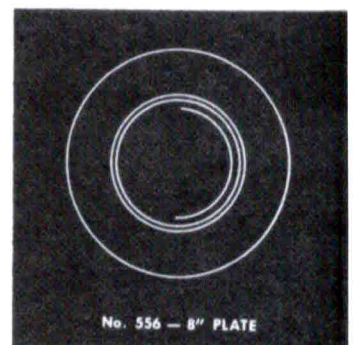
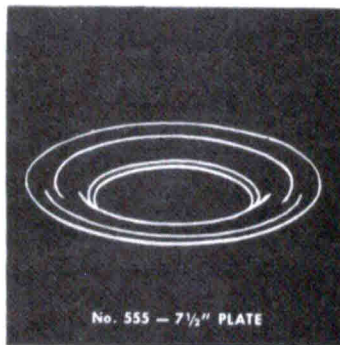
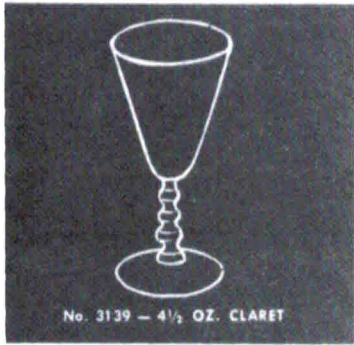
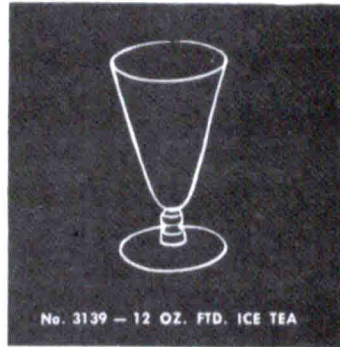

THE CAMBRIDGE GLASS COMPANY, CAMBRIDGE, OHIO, U. S. A.

3779 Line



No. 3779 — GOBLET



No. 3779 — 9 OZ. TALL GOBLET



No. 3779 — 6 OZ. TALL SHERBET



No. 3779 — 9 OZ. LOW GOBLET



No. 3779 — 6 OZ. LOW SHERBET



No. 3779 — 12 OZ. FTD. ICE TEA

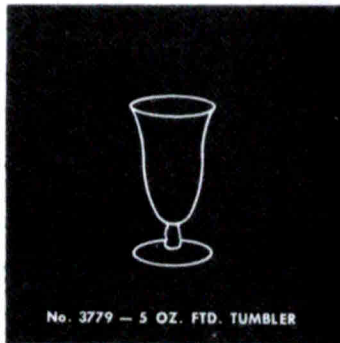

No. 3779 — 5 OZ. FTD. TUMBLER



No. 3779 — 3 OZ. COCKTAIL



No. 3779 — 2½ OZ. WINE



No. 3779 — 1 OZ. CORDIAL

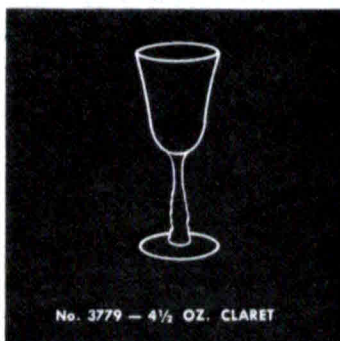

No. 3779 — 4½ OZ. CLARET

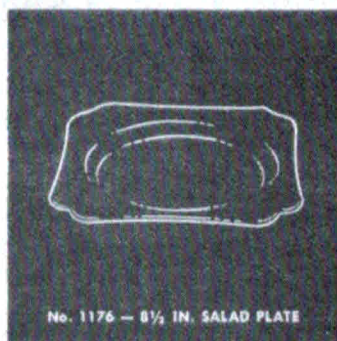

No. 1176 — 8½ IN. SALAD PLATE



No. 3779 — 4½ OZ. OYSTER COCKTAIL

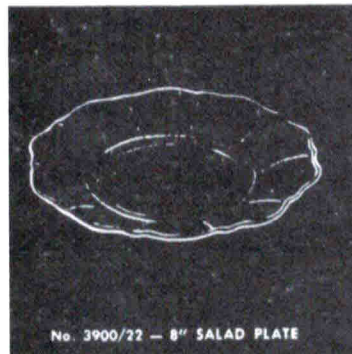
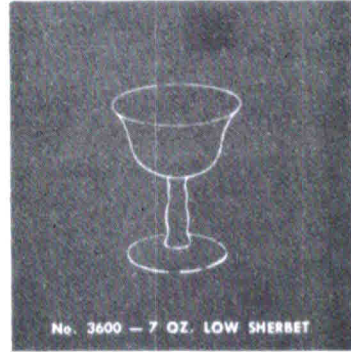
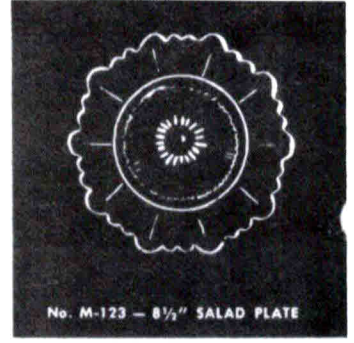
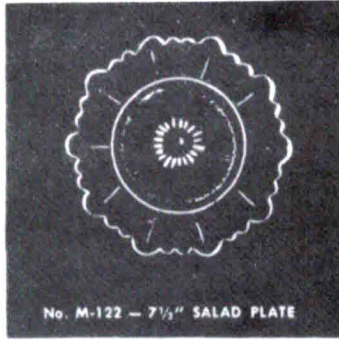

3600 Line



THE CAMBRIDGE GLASS COMPANY, CAMBRIDGE, OHIO, U.S.A.



No. 3625 - 10 OZ. GOBLET



No. 3625 - 7 OZ. TALL SHERBET



No. M-122 - 7 1/2" SALAD PLATE

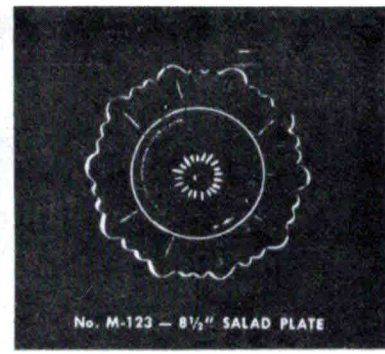

No. M-123 - 8 1/2" SALAD PLATE



No. 3625
10 OZ. FOOTED TUMBLER

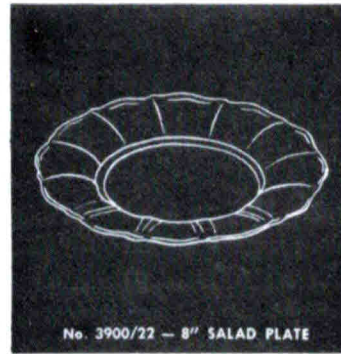

No. 3900/22 - 8" SALAD PLATE



No. 3625 - 3 OZ. COCKTAIL

3625 Line



No. 3625 - 2 1/2 OZ. WINE



No. 3625 - 4 1/2 OZ. CLARET

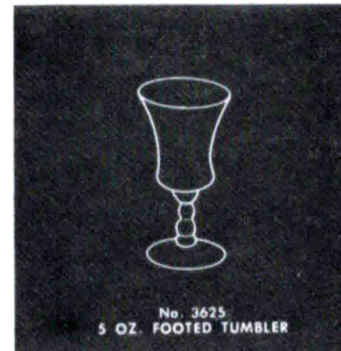

No. 3625
5 OZ. FOOTED TUMBLER



No. 3625 - 1 OZ. CORDIAL



No. 3625
12 OZ. FOOTED ICE TEA



No. 3625 - 7 OZ. LOW SHERBET



No. 3625
4 1/2 OZ. OYSTER COCKTAIL

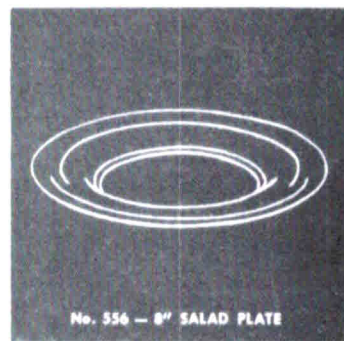
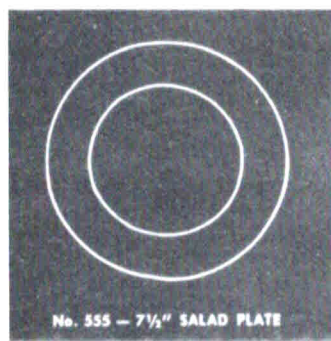

Simplicity

No. 3790



THE CAMBRIDGE GLASS COMPANY, CAMBRIDGE, OHIO, U. S. A.

Queen Mary

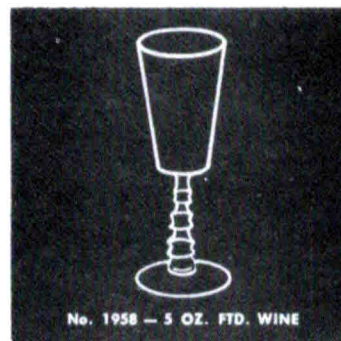
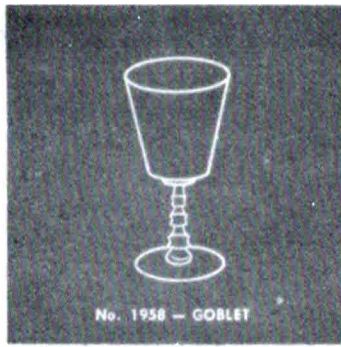

THE CAMBRIDGE GLASS COMPANY, CAMBRIDGE, OHIO, U. S. A.



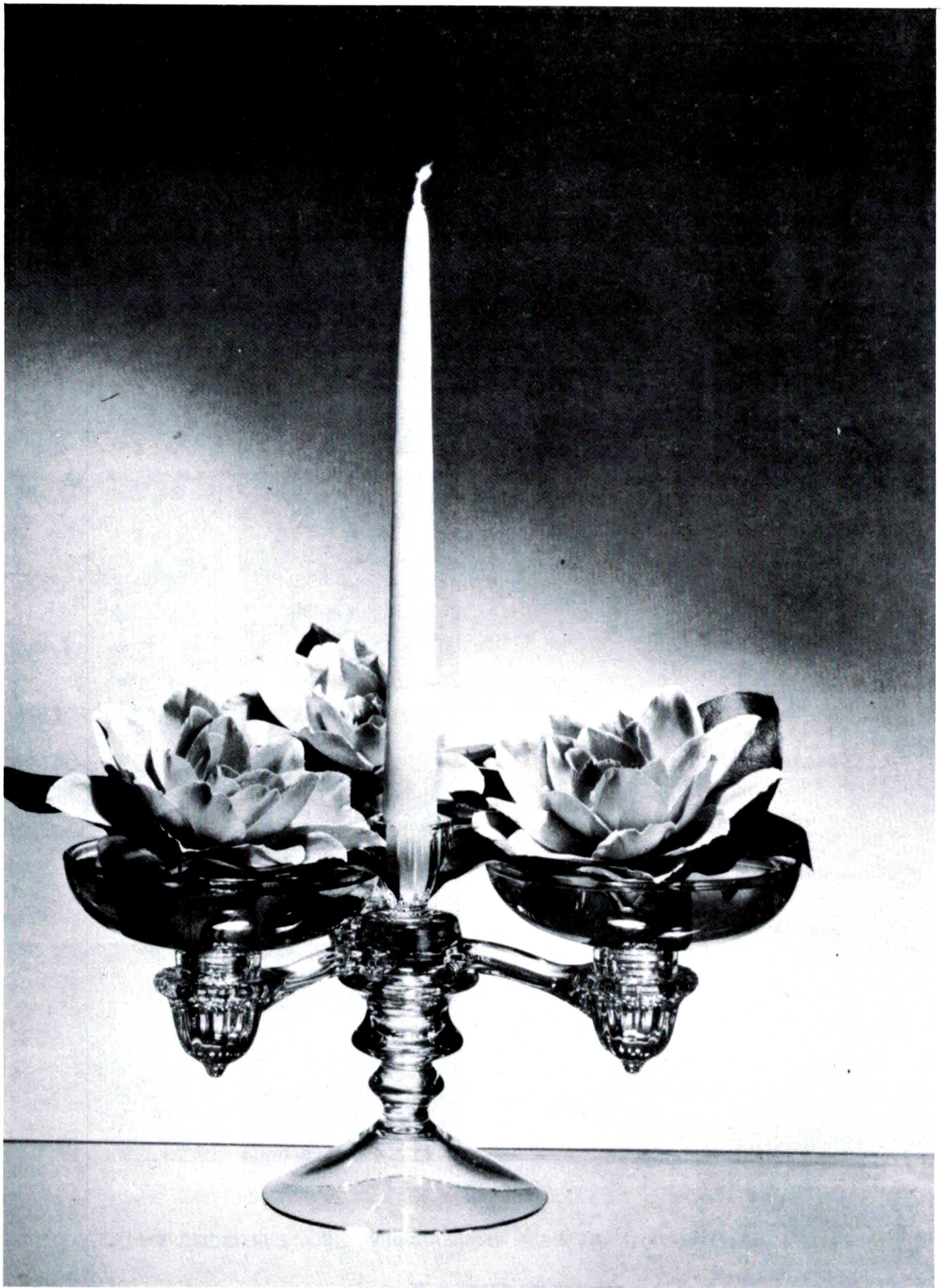

Accessories for

CAMBRIDGE ARMS

CANDELABRA

EPERGNES

HURRICANE LAMPS

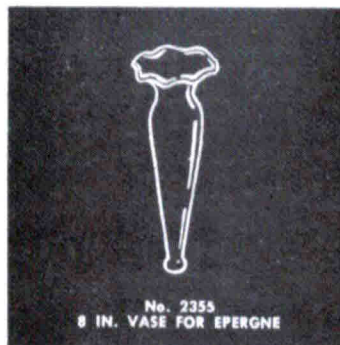
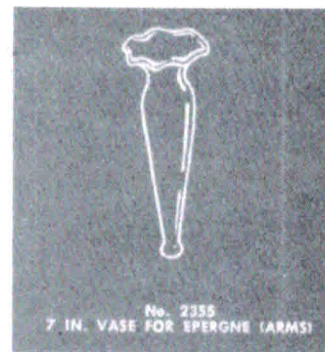
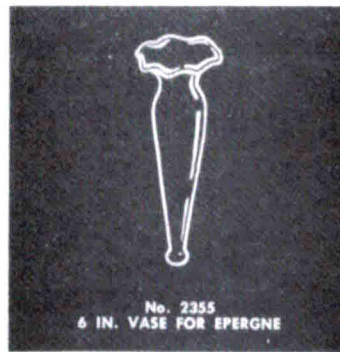

THE CAMBRIDGE GLASS COMPANY, CAMBRIDGE, OHIO, U. S. A.

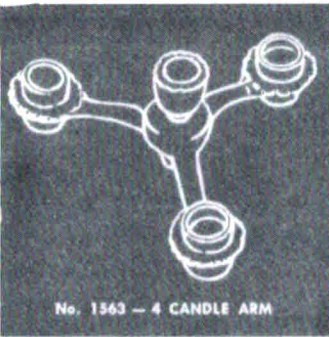

No. 1363 - 4 CANDLE ARM

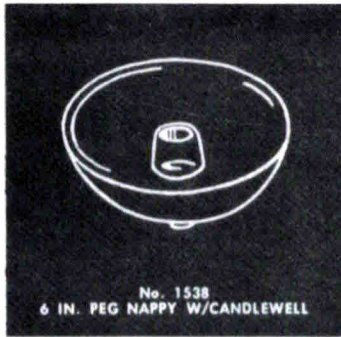

No. 1538
6 IN. PEG NAPPY W/CANDLEWELL



No. 1629 - CHIMNEY FOR
255 HURRICANE LAMP

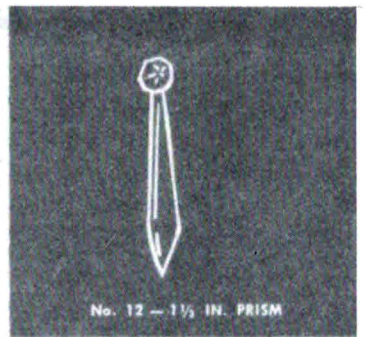

No. 12 - 1 1/2 IN. PRISM



No. 19 - BOBECHÉ W/PINS (ARMS)



No. 1632 - CHIMNEY FOR
1613 HURRICANE LAMP



No. 1606
6 1/2 IN. CHIMNEY, ETCHED

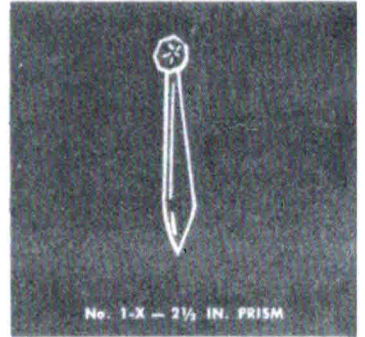

No. 1-X - 2 1/2 IN. PRISM



No. 27 - BOBECHÉ W/PINS



No. 1606 - CHIMNEY FOR
1617 AND 1603 HURRICANE LAMP

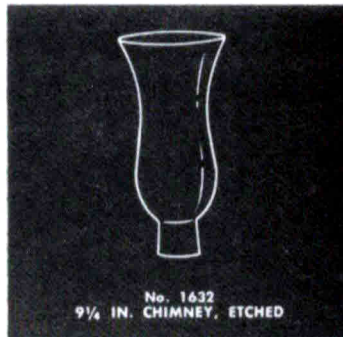

No. 1632
9 1/4 IN. CHIMNEY, ETCHED

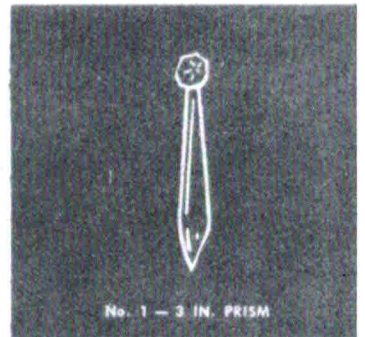

No. 1 - 3 IN. PRISM



No. 29 - BOBECHÉ W/PINS

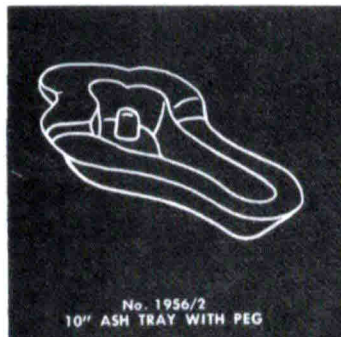

No. 1956/2
10" ASH TRAY WITH PEG

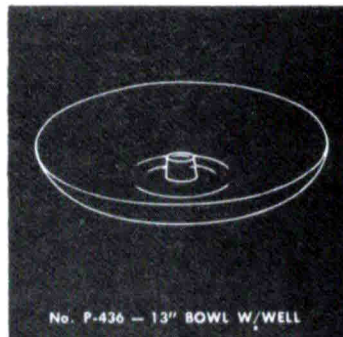

No. P-436 - 13" BOWL W/WELL



No. 1633 - 5 IN. PEG VASE

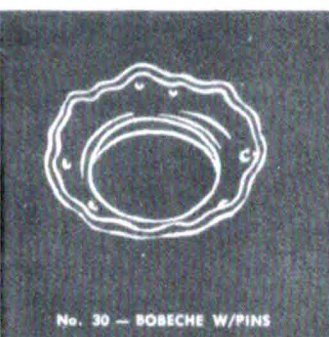

No. 30 - BOBECHÉ W/PINS

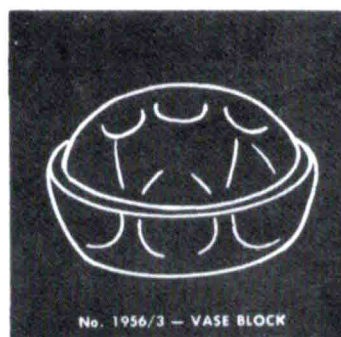

No. 1956/3 - VASE BLOCK

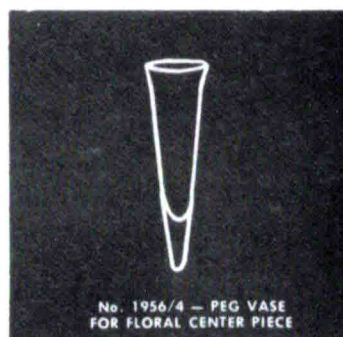

No. 1956/4 - PEG VASE
FOR FLORAL CENTER PIECE

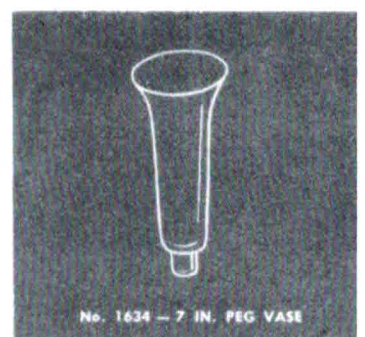

No. 1634 - 7 IN. PEG VASE





Modern

MADE IN CRYSTAL AND PINK

PLATINUM BAND



No. 3791 - SHERBET



No. 3791 - 12 OZ. FTD. TUMBLER

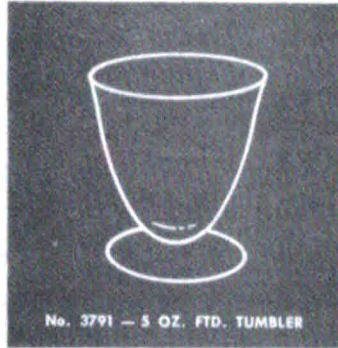

No. 3791 - 5 OZ. FTD. TUMBLER



No. 3791 - COCKTAIL



No. 3791 - GOBLET (no stem)



No. 3791 - CLARET

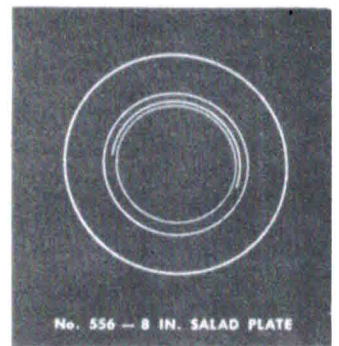

No. 556 - 8 IN. SALAD PLATE



No. 3790 — SHERBET

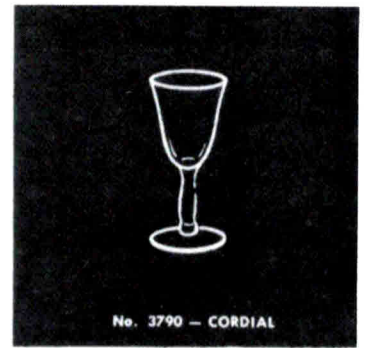

No. 3790 — CORDIAL



No. 3790 — WINE

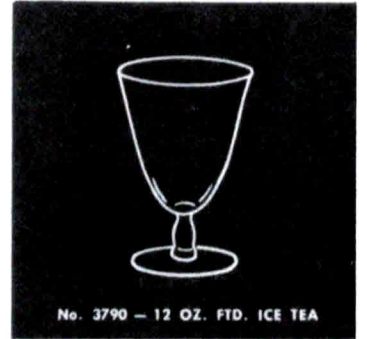

No. 3790 — 12 OZ. FTD. ICE TEA



No. 3790
5 OZ. JUICE OR CLARET



No. 556 — 8" SALAD PLATE

No. 3790 — COCKTAIL

No. 3790 — GOBLET

Victory

PLATINUM BAND

Triumph

DECORATED PLATINUM BAND

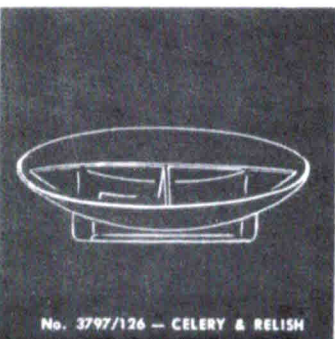
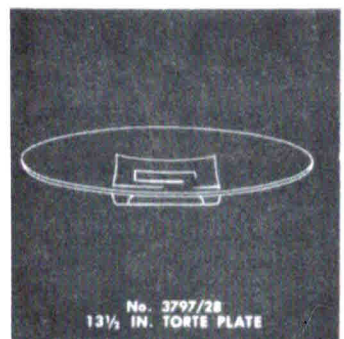
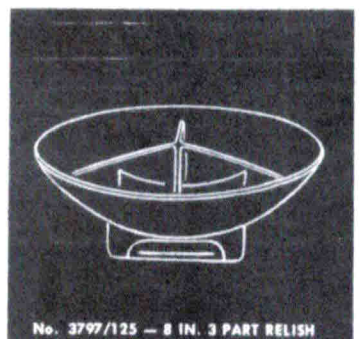
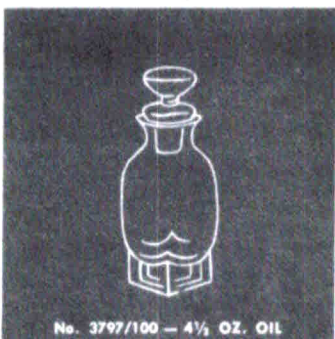
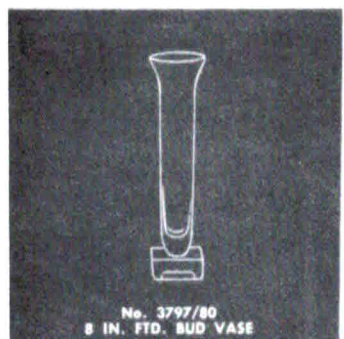
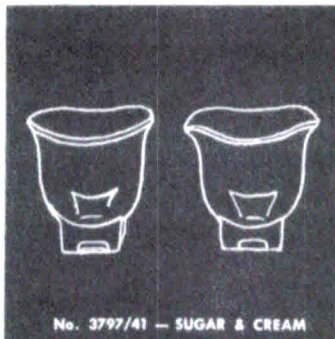
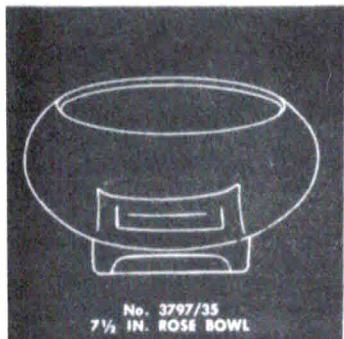
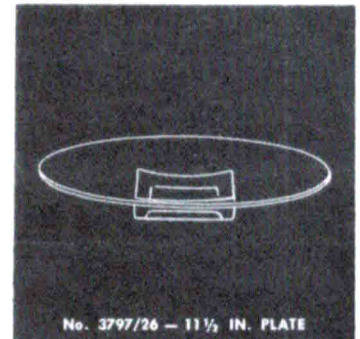
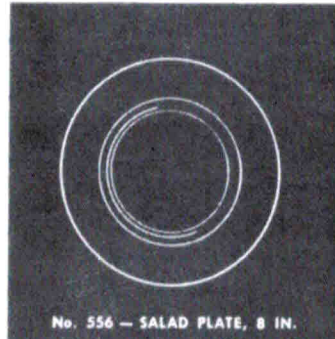
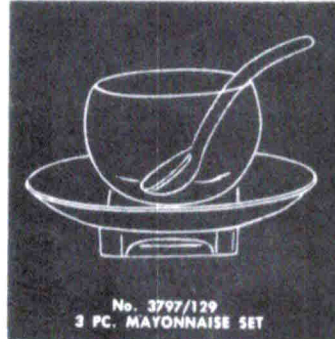
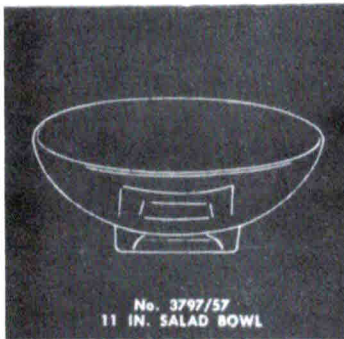

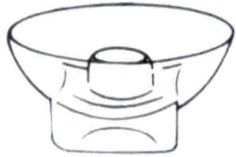

No. 3797/67 — CANDLESTICK



No. 3797/103 — CELERY

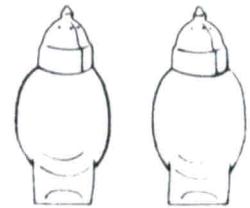

No. 3797/76 — SALT & PEPPER



No. 3798 — SHERBET

No. 3798 — 12 OZ. FTD. TUMBLER



No. 3798 — GOBLET



No. 3798 — COCKTAIL



No. 3798 — 5 OZ. FTD. TUMBLER



GOLD BAND EDGE WITH HAIRLINE

Wedding Band

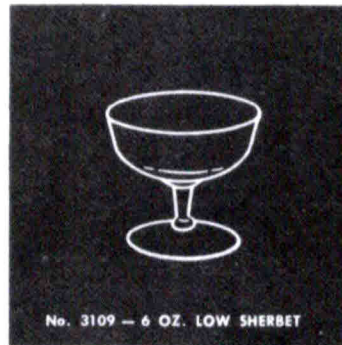
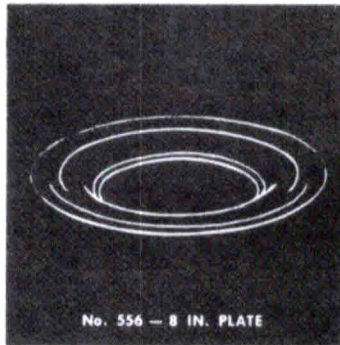
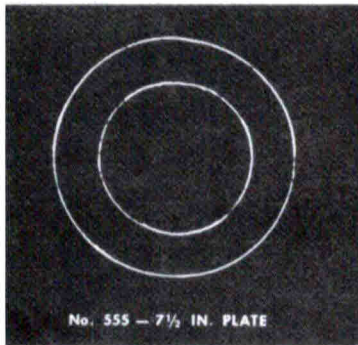
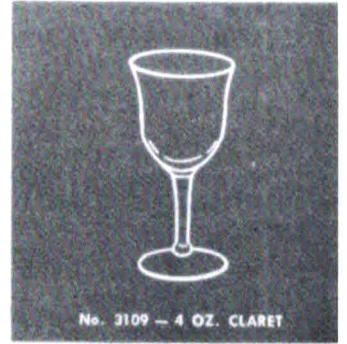



No. 3700 - 3 OZ. COCKTAIL



No. 3700 - 4 1/2 OZ. CLARET



No. 3700 - 2 1/2 OZ. WINE

No. 3700 - GOBLET



No. 3700
4 1/2 OZ. OYSTER COCKTAIL



No. 3109 - 5 OZ. FTD. TUMBLER

No. 3109 - 9 OZ. GOBLET



No. 3700 - 1 OZ. CORDIAL



No. 3700 - 12 OZ. FTD. ICE TEA



No. 3700 - 10 OZ. FTD TUMBLER



No. 3700 - 6 OZ. TALL SHERBET



No. 3700 - 6 OZ. LOW SHERBET

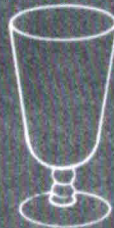

No. 3700 - 5 OZ. FTD. JUICE

D/1045 (gold edge) WILDFLOWER

D/1051 (gold edge) ROSE POINT

D/1041 (gold encrusted) ROSE POINT

D/1047 (gold encrusted) WILDFLOWER

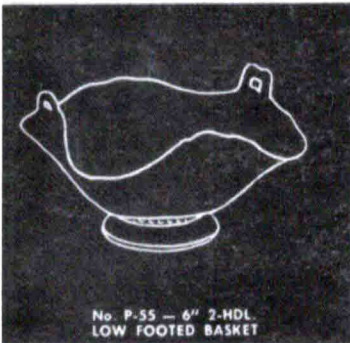

No. P-55 — 6" 2-HDL
LOW FOOTED BASKET



No. D/1047 (Wildflower)
(gold encrusted)
6" 2-PART RELISH

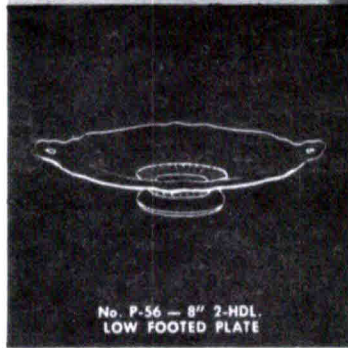

No. P-56 — 8" 2-HDL
LOW FOOTED PLATE



No. D/1041 (Rose Point)
(gold encrusted)
6" FOOTED COMPORT



THE CAMBRIDGE GLASS COMPANY, CAMBRIDGE, OHIO, U. S. A.

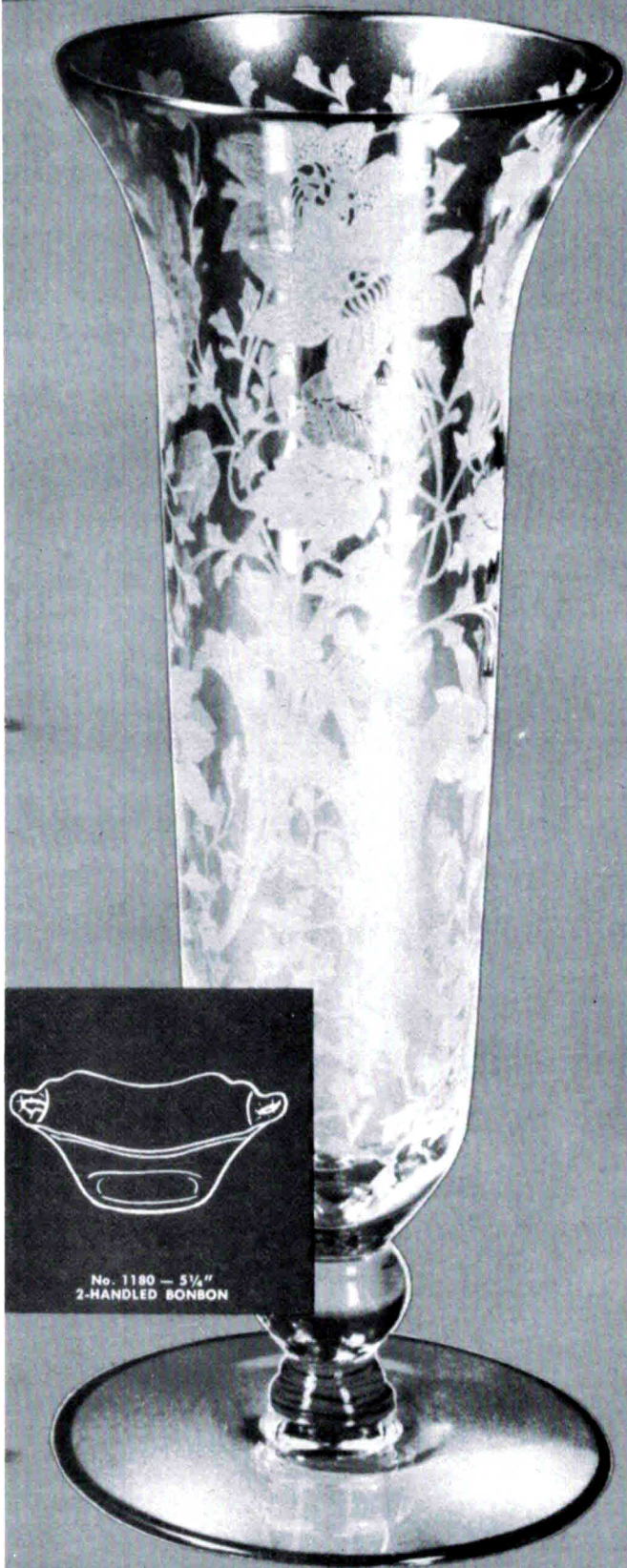

No. D/1045 (Wildflower)
8" 6004 VASE
(gold edge)

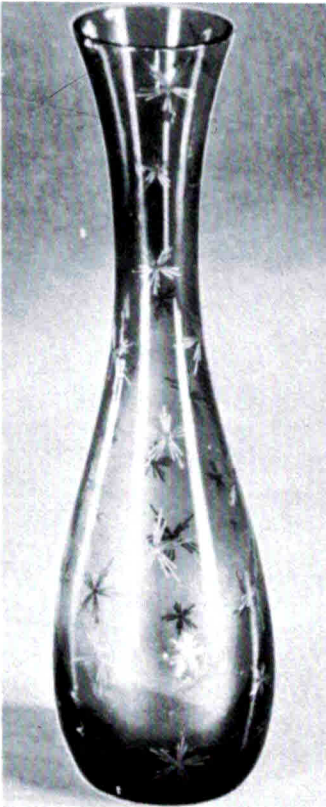

No. 1528 — VASE,
SMOKE DECORATE
(STARS)

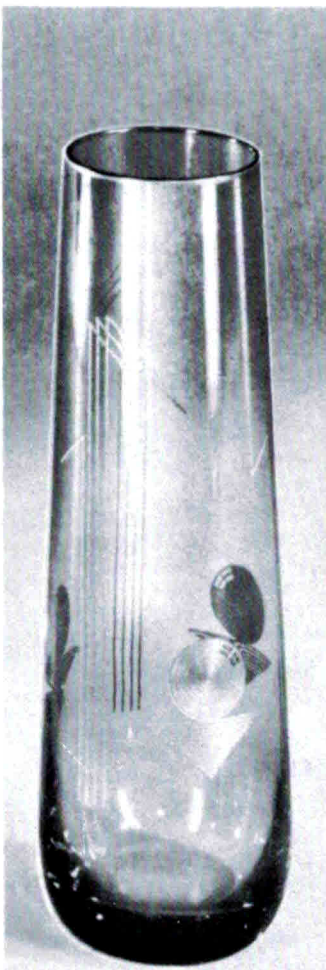

No. 1519 — VASE,
SMOKE DECORATE
(MOON)

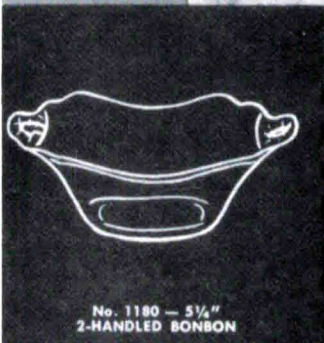

No. 1180 — 5 1/4"
2-HANDLED BONBON

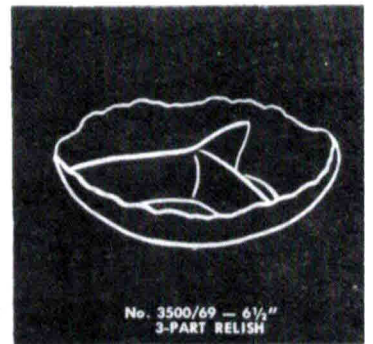

No. 3500/69 — 6 1/2"
3-PART RELISH



No. 3900/40 — IND.
SUGAR AND CREAM



